



HIGH EFFICIENCY AIR TO WATER HEAT PUMPS

AWHS

SERIES



TECHNICAL MANUAL

Incorporated in this document are the following:

- Declaration of conformity
- Technical manual
- Dimensional drawing



RETAIN FOR FUTURE REFERENCE



Multiple instructions:
Consult the specific part



Read and understand
the instructions before
undertaking any work on
the unit

Reproduction, data storage and transmission, even partial, of this publication, in any form, without the prior written authorisation of the Company, is prohibited. The Company can be contacted for all inquiries regarding the use of its products.

The Company follows a policy of continuous product development and improvement and reserves the right to modify specifications, equipment and instructions regarding use and maintenance at any time, without notice.

Declaration of conformity

We declare under our own responsibility that the below equipment complies in all parts with the CEE and EN directives.

The declaration of conformity is enclosed to the technical booklet enclosed with the unit. The unit contains fluorinated greenhouse gases.

INDEX

1. INTRODUCTION	5
1.1 Preliminary information	5
1.2 Aim and content of the manual	5
1.3 How to store this manual	5
1.4 Manual updates	5
1.5 How to use this manual	5
1.6 Potential risks	6
1.7 General description of symbols used	7
1.8 Safety symbols used	8
1.9 Limitations and prohibited use	8
1.10 Unit identification	9
2. SAFETY	10
2.1 Warning re potentially hazardous toxic substances	10
2.2 Refrigerant handling	10
2.3 Prevention of inhalation of high vapor concentrations	11
2.4 Procedures in the event of accidental release of refrigerant	11
2.5 Main Toxicological information on the type of refrigerant used	11
2.6 First aid measures	11
3. TECHNICAL CHARACTERISTICS	12
3.1 Unit description	12
3.2 Other versions	13
3.3 Accessories description	14
3.4 Technical data	16
3.5 Operation limits	21
3.6 Domestic hot water production	23
3.7 Compressor capacity steps	25
3.8 Correction tables	26
3.9 Sound data	27
4. INSTALLATION	30
4.1 General safety guidelines and use of symbols	30
4.2 Workers' health and safety	30
4.3 Personal protective equipment	30
4.4 Inspection	31
4.5 Storage	31
4.6 Unpacking	31
4.7 Lifting and handling	31
4.8 Location and minimum technical clearances	32
4.9 Installation of rubber vibration dampers	35
4.10 Serial interface card RS485	35
4.11 Installation of condensate drip tray	36
4.12 Hydraulic connections	37
4.13 Chemical characteristics of the water	37
4.14 Hydraulic components	38
4.15 User circuit minimum water content	39
4.16 Domestic hot water (dhw) minimum water content	39
4.17 Filling the hydraulic circuit	39
4.18 Emptying the installation	39
4.19 Typical installations	40
4.20 Wiring connections: Preliminary safety information	41
4.21 Electrical data	42
4.22 Electrical connections	43
4.23 Positioning of the user circuit water inlet sensor (BTI)	46
4.24 Positioning of the domestic hot water circuit sensor (BTS)	46
4.25 Refrigerant circuit layout	47
5. UNIT START UP	49

5.1 Preliminary Checks.....	49
5.2 Position of the control panel	51
5.3 Description of the control panel	51
5.4 To remote the control	53
6. USE	54
6.1 Switch the unit on	54
6.2 Stop	55
6.3 Set points.....	56
6.4 PROBES key	56
6.5 ALARM key	56
6.6 CIRC key	57
6.7 SERVICE key	60
6.8 Acoustic signal silencing.....	71
7. MAINTENANCE OF THE UNIT	72
7.1 General warnings.....	72
7.2 Drive access	72
7.3 Scheduled maintenance	73
7.4 Periodical checks and start up.....	73
7.5 Refrigerant circuit repair	76
8. DECOMMISSIONING.....	76
8.1 Disconnect the unit	76
8.2 Disposal, recovery and recycling	76
8.3 RAEE directive (only for EC countries).....	77
9. DIAGNOSIS & TROUBLESHOOTING	77
9.1 Fault finding	77

1. INTRODUCTION

1.1 Preliminary information

Reproduction, storage or transmission of any part of this publication in any form, without the prior written consent of the Company, is prohibited.

The unit to which these instructions refer, is designed to be used for the the purposes described and to be operated in accordance with these instructions.

The Company will not be liable for claims for damage caused to persons, animals, material goods or property caused by improper installation, adjustment and maintenance or improper use. Any use not specified in this manual is prohibited.

This document is intended to provide information only and does not form a contract with third parties.

The Company pursues a policy of constant improvement and development of its products and therefore reserves the right to change the specifications and the documentation at any time, without notice and without obligation to update existing equipment.

1.2 Aim and content of the manual

These instructions are intended to provide the information required for the selection, installation, use and maintenance of the unit.

They have been prepared in accordance with the European Union laws and with the technical standards in force at the date of issue of the instructions.

The instructions contain all the necessary information to prevent any reasonably foreseeable misuse.

1.3 How to store this manual

The manual must be kept in a suitable place with easy access for users and operators, protected from dust and damp.

The manual must always accompany the unit during the entire life cycle of the same and therefore must be transferred to any subsequent user.

1.4 Manual Update

It is recommended that the manual is updated to the latest revision available.

If updates are sent to the customer they must be added to this manual.

The latest information regarding the use of its products is available by contacting the Company.

1.5 How to use this manual



The manual is an integral part of the unit.

Users or operators must consult the manual before performing any operation and especially so when transporting, handling, installing, maintaining, or dismantling the unit in order to eliminate uncertainty and reduce risk.



In these instructions symbols have been used (described in the following paragraphs) to draw the attention of operators and users to the operations that have a higher risk and which must be performed safely.

1.6 Potential Risks

Whilst the unit has been designed to minimize any risk posed to the safety of people who will interact with it, it has not been technically possible to eliminate completely the causes of risk. It is therefore necessary to refer to the requirements and symbolism below:

LOCATION OF RISK	POTENTIAL RISK	METHOD OF INJURY	PRECAUTIONS
Thermal heat exchangers.	Small stab wounds.	Contact	Avoid any contact, use protective gloves.
Fan and fan grilles.	Cuts, eye damage, broken bones.	Insertion of sharp objects through the grid while the fans are operating.	Never put objects through the protection grilles.
Internal component: compressors and discharge pipes	Burns.	Contact	Avoid any contact, use protective gloves.
Internal component: electric cables and metallic parts	Electrocution, severe burns.	Defect in the supply cable insulation, live metallic parts.	Adequate protection of power cables, ensure correct earthing of all metal parts.
External to unit: unit enclosure	Poisoning, severe burns.	Fire due to short circuit or overheating of the supply cable external to unit.	Size cables and mains protection system in accordance with iee regulations.
Low pressure safety valve.	Poisoning, severe burns.	High evaporating pressure causing a refrigerant discharge during maintenance.	Carefully check the evaporating pressure during the maintenance operations. Use all personal protective equipment required by the law. PPE must also protect against gas leaks from the safety valve. The outlet of these valves is directed to avoid causing damage to persons or goods.
High pressure safety valve.	Poisoning, severe burns, hearing loss.	Activation of the high pressure safety valve with the refrigerant circuit open.	If possible, do not open the refrigerant circuit valve; carefully check the condensing pressure; use all the personal protective equipment required by law. PPE must also protect against gas leaks from the safety valve. The outlet of these valves is directed to avoid causing damage to persons or goods.
Entire unit	External fire	Fire due to natural disasters or combustions of elements nearby unit	Provide the necessary fire-fighting equipment
Entire unit	Explosion, injuries, burns, poisoning, folgoramento for natural disasters or earthquake.	Breakages, failures due to natural disasters or earthquake	Plan the necessary precautions both electrical (suitable differential magneto and electrical protection of the supply lines; greatest care during the connections of the metal parts), and mechanical (special anchors or seismic vibrations to prevent breakages or accidental falls).

1.7 General Description of Symbols Used

Safety symbols combined in accordance with ISO 3864-2:



BANNED

A black symbol inside a red circle with a red diagonal indicates an action that should not be performed.



WARNING

A black graphic symbol added to a yellow triangle with black edges indicates danger.



ACTION REQUIRED

A white symbol inserted in a blue circle indicates an action that must be done to avoid a risk.

Safety symbols combined in accordance with ISO 3864-2:



The graphic symbol “warning” is qualified with additional safety information (text or other symbols).

1.8 Safety symbols used



GENERAL RISK

Observe all signs placed next to the pictogram. The failure to follow directions may create a risk situation that may be injurious to the user.



ELECTRICAL HAZARD

Observe all signs placed next to the pictogram. The symbol indicates components of the unit and actions described in this manual that could create an electrical hazard.



MOVING PARTS

The symbol indicates those moving parts of the unit that could create risk.



HOT SURFACES

The symbol indicates those components with high surface temperature that could create risks.



SHARP SURFACES

The symbol indicates components or parts that could cause stab wounds.



EARTH CONNECTION

The symbol identifies Earthing connection points in the unit.



READ AND UNDERSTAND THE INSTRUCTIONS

Read and understand the instructions of the machine before any operations.



RECOVER OR RECYCLE MATERIAL

1.9 Limitations and prohibited use

The machine is designed and built exclusively for the uses described in "Limitations of use" of the technical manual. Any other use is prohibited because it may pose a potential risk to the health of operators and users.







The unit is not suitable for operations in environments:

- excessively dusty or potentially explosive atmospheres;
- where there are vibrations;
- where there are electromagnetic fields;
- where there are aggressive atmospheres

1.10 Unit identification

Each unit has a rating plate that provides key information regarding the machine. The rating plate may differ from the one shown below as the example is for a standard unit without accessories. For all electrical information not provided on the label, refer to the wiring diagram. A facsimile of the label is shown below:

		Manufacturer: PD322111		
AWHS.0170.SLN		123456		
Modello Model		Matricola Serial number		
2		16/2018		
Categoria PED PED Category		Data di fabbricazione Manufacture date		
R410A	2	2088		
Tipo refrigerante Refrigerant type	Gruppo fluido Fluid group	GWP		
C1 9,5 Kg	C2	19,84 ton		
C3	C4	CO ₂ Equivalente CO ₂ Equivalente		
Carica refrigerante Refrigerant charge				
400V-3ph-50Hz		43,20 A	20,20 kW	
Tensione-Fasi-Frequenza Voltage-Phases-Frequency		F.L.A. (A)	F.L.I. (kW)	
LATO BASSA PRESSIONE LOW PRESSURE SIDE		LATO ALTA PRESSIONE HIGH PRESSURE SIDE		
29,5 bar		45 bar		
PS		PS		
Min	Max	Min	Max	
-30 °C	+130 °C	-30 °C	+130 °C	
Temperatura di progetto Design temperature		Temperatura di progetto Design temperature		
Peso a vuoto Weight				
Contiene gas fluorurati ad effetto serra disciplinati dal protocollo di Kyoto Contains fluorinated greenhouse gasses covered by the Kyoto protocol				
				



The product label should never be removed from the unit.

2. SAFETY

2.1 Warning re potentially hazardous toxic substances

2.1.1 Identification of the Type of Refrigerant Fluid Used: R410A

- Difluoromethane (HFC-32) 50% by weight CAS No.: 000075-10-5
- Pentafluoroethane (HFC-125) 50% by weight CAS No.: 000354-33-6

2.1.2 Identification of the Type of Oil Used.

The lubricant used is polyester oil. Please refer to the information provided on the compressor data plate.



For further information regarding the characteristics of the refrigerant and oil used, refer to the safety data sheets available from the refrigerant and oil manufacturers.

Main Ecological Information Regarding the Types of refrigerants Fluids used.



ENVIRONMENTAL PROTECTION : Read the ecological information and the following instructions carefully.

2.1.3 Persistence and degradation

The refrigerants used decompose in the lower atmosphere (troposphere) relatively quickly. The decomposed products are highly dispersible and therefore have a very low concentration. They do not influence the photochemical smog which is not among the VOC volatile organic compounds (as stipulated in the guidelines to the UNECE). The constituent refrigerants of R407C (R32, R125 and R134a), do not damage the ozone layer. These substances are regulated under the Montreal Protocol (revised 1992) and regulations EC no. 2037/2000 of 29 June 2000.

2.1.4 Effects of discharges

Discharges into the atmosphere of this product does not cause a long-term contamination.

2.1.5 Exposure controls and personal protection

Wear protective clothing and gloves, protect your eyes and face

2.1.6 Professional exposure limits

R410A

HFC-32 TWA 1000 ppm

HFC-125 TWA 1000 ppm

2.2 Refrigerant handling



Users and maintenance personnel must be adequately informed about the possible risks of handling potentially toxic substances. Failure to follow such instructions can cause damage to personnel or to the unit.

2.3 Prevent inhalation of high vapor concentration

Atmospheric concentrations of refrigerant must be minimized and kept to a level that is below the occupational exposure limit. Vapor is heavier than air and can form dangerous concentrations near the ground where the ventilation rate is lower. Always ensure adequate ventilation. Avoid contact with open flames and hot surfaces as this can cause toxic and irritating decomposition products to form. Avoid contact between liquid refrigerant and the eyes or skin.

2.4 Procedures to be adopted in the event of accidental release of refrigerant

Ensure suitable personal protection (especially respiratory protection) during cleaning operations.

If deemed safe, isolate the source of the leak. If the leakage is small and if adequate ventilation is provided, allow the refrigerant to evaporate. If the loss is substantial ensure that measures are taken to adequately ventilate the area.

Contain spilled material with sand, earth or other suitable absorbent material.

Do not allow the refrigerant to enter drains, sewers or basements, as pockets of vapor can form.

2.5 Main Toxicological Information Regarding the Type of refrigerant used

2.5.1 Inhalation

A high atmospheric concentration can cause anaesthetic effects with possible loss of consciousness. Prolonged exposure may lead to irregular heartbeat and cause sudden death. Higher concentrations may cause asphyxia due to the reduced oxygen content in the atmosphere.

2.5.2 Contact with skin

Splashes of nebulous liquid can produce frostbite. Probably not hazardous if absorbed through the skin. Repeated or prolonged contact may remove the skin's natural oils, with consequent dryness, cracking and dermatitis.

2.5.3 Contact with eyes

Splashes of liquid may cause frostbite.

2.5.4 Ingestion

While highly improbable, may produce frostbite.

2.6 First Aid Measures



Adhere scrupulously to the warnings and first aid procedures indicated below.

2.6.1 Inhalation

Move the person away from the source of exposure, keep him/her warm and let him/her rest. Administer oxygen if necessary. Attempt artificial respiration if breathing has stopped or shows signs of stopping. If the heart stops, perform external heart massage. Seek medical assistance.

2.6.2 Contact with skin

In case of contact with skin, wash immediately with lukewarm water. Thaw tissue using water. Remove contaminated clothing. Clothing may stick to the skin in case of frostbite. If irritation, swelling or blisters appear, seek medical assistance.

2.6.3 Contact with eyes

Rinse immediately using an eyewash or clean water, keeping eyelids open, for at least ten minutes. Seek medical assistance.

2.6.4 Ingestion

Do not induce vomiting. If the injured person is conscious, rinse his/her mouth with water and make him/her drink 200-300ml of water. Seek immediate medical assistance.

2.6.5 Further medical treatment

Treat symptoms and carry out support therapy as indicated. Do not administer adrenaline or similar sympathomimetic drugs following exposure, due to the risk of cardiac arrhythmia.

3. TECHNICAL CHARACTERISTICS

3.1 Unit description

The series of high efficiency heat pumps has been specifically designed for use with radiant floor heating systems or those applications where it is necessary to have maximum efficiency when heating.

They have been optimized on heating mode, are able to produce water up to 60°C and can operate down to -20°C ambient temperature. All versions are supplied with reverse cycle valve used for winter defrost; standard version support schemes for use of heat pump technology for heating. The RV versions are also able to produce cold water. The noise is extremely low thanks to the use of a special floating vibration damping system which allows a noise reduction of about 10-12 dB(A) (Optional).

3.1.1 Frame

All units are made from hot-galvanised sheet steel, painted with polyurethane powder enamel and stoved at 180°C to provide maximum protection against corrosion. The frame is self-supporting with removable panels. All screws and rivets used are made from stainless steel. The standard colour of the units is RAL9018.

3.1.2 Refrigerant circuit

The refrigerant utilised is R410A. The refrigerant circuit is assembled using internationally recognised brand name components with all brazing and welding being performed in accordance with ISO 97/23. The refrigerant circuit includes: sight glass, filter drier, two thermal expansion valves (one for cooling mode, one for heating mode) with external equalizer, 4 way reversing valve, check valves, liquid receiver, Schrader valves for maintenance and control, pressure safety device (for compliance with PED regulations).

3.1.3 Compressors

The compressors used are a high performance scroll type that incorporates a special scroll design which enhances the efficiency of the refrigerant cycle when the source temperature is low. In all units the compressors are connected in tandem. The compressors are all supplied with a crankcase heater and thermal overload protection by a Klaxon embedded in the motor winding. They are mounted in a separate enclosure in order to be separated from the air stream thus enabling them to be maintained even if the unit is operating. Access to this enclosure is by the front panel of the unit. The crankcase heater is always powered when the compressor is in stand-by.

3.1.4 Source heat exchanger

The source heat exchanger is made from 3/8" copper pipes and 0,1mm thick aluminium fins with the tubes being mechanically expanded into the aluminium fins in order to maximise heat transfer. Furthermore, the design guarantees a low air side pressure drop thus enabling the use of low rotation speed (and hence low noise) fans. All heat exchangers are supplied standard with fins hydrophilic coating.

3.1.5 User heat exchangers

The user heat exchanger is a braze welded, plate type heat exchanger, manufactured from AISI 316 stainless steel. The use of this type of exchanger results in a massive reduction of the refrigerant charge of the unit compared to a traditional shell-in-tube type. A further advantage is a reduction in the overall dimensions of the unit. The exchangers are factory insulated with flexible close cell material and can be fitted with an antifreeze heater (accessory). Each exchanger is fitted with a temperature sensor on the discharge water side for antifreeze protection.

3.1.6 Fans

The fans are direct drive axial type with aluminium aerofoil blades, are statically and dynamically balanced and are supplied complete with a safety fan guard complying with the requirements of EN 60335. They are fixed to the unit frame via rubber anti-vibration mountings. The electric motors are 6 poles type rotating at approximately 900 rpm. In the SLN version the fans are 8 poles type (approx 600 rpm). As standard, all units are fitted with a pressure operated fan speed controller. The motors are fitted with integrated thermal overload protection and have a moisture protection rating of IP 54.

3.1.7 Microprocessors

All units are supplied as standard with microprocessor controls. The microprocessor controls the following functions: control of the water temperature, antifreeze protection, compressor timing, compressor automatic starting sequence (For multiple compressors), alarm reset. The control panel is supplied with display showing all operational icons. The microprocessor is set for automatic defrost (when operating in severe ambient conditions) and for summer/ winter change over (only for RV versions). The control also manages the anti-legionella program, the integration with other heating sources (electric heaters, boilers, solar panels etc), the operation of a three port modulating valve (for diverting to DHW or heating) and both the heating circuit pump and the domestic hot water circuit pump. If required (available as an option), the microprocessor can be configured in order for it to connect to a site BMS system thus enabling remote control and management. The technical department can discuss and evaluate, in conjunction with the customer, solutions using MODBUS protocols.

3.1.8 Electric enclosure

The enclosure is manufactured in order to comply with the requirements of the electromagnetic compatibility standards CEE EN60204. Access to the enclosure is achieved by removing the front panel of the unit. The following components are supplied as standard on all units: main switch, a sequence relay that disables the power supply in the event that the phase sequence is incorrect (scroll compressors can be damaged if they rotate in the wrong direction), thermal overloads (protection of pumps and fans), compressor fuses, control circuit automatic breakers, compressor contactors, fan contactors and pump contactors. The terminal board has volt free contacts for remote ON-OFF, Summer/ winter change over (heat pumps only) and general alarm.

3.1.9 Control and protection devices

All units are supplied with the following controls and protections: user water return temperature sensor, antifreeze protection temperature sensor installed on users water output, domestic hot water supply and return temperature sensors (only versions P2S), high pressure manual reset, low pressure automatic reset, compressor thermal protection, air fan, thermal protection, pressure transducer (used to optimize the defrost cycle and to adjust the fan speed depending on ambient conditions), flow switch. All units except for SE versions are also fitted with a temperature probe sensor with "Energy Saving" function, supplied in a separate plastic box, which can be used to stop the pump use during periods of stand-by, when the water temperature reaches the set point. Doing this the power consumption of the unit is strongly reduced. The probe sensor must be positioned in the hydraulic compensator present at the screening technique. The domestic hot water circuit (only DHW versions) is already equipped with this probe, but it must be installed in the user circuit.

3.1.10 User flow switch

The flow utility is installed as standard on all units and disables the operation of the unit in case of abnormal water flow in the system. The flow switch is made of a blade system fitted in the flow of the water; it is combined with two permanent magnets that assess the amount of water in transit and, in function of the measured parameter, enable or not the operation of the unit.

3.2 Other versions

3.2.1 Version Heating only

The heating only version is factory set and locked to operate only in heating mode whilst.

3.2.2 Version RV

This version uses 2 hydraulic connections and is able to produce hot water in winter and cold water in summer. The unit is combined with a 2-pipe system.

3.2.3 SE/ACF Version

Standard efficiency version, according to ERP2018 standard. Unit equipped with AC fans.

3.2.4 SE Version

Standard efficiency version, according to ERP2018 standard. Unit equipped with EC fans.

3.2.5 ACF Version

High efficiency version, according to ERP2018 standard. Unit equipped with AC fans.

3.2.6 Standard Version

High efficiency version, according to ERP2018 standard. Unit equipped with EC fans.

This version includes the complete acoustic insulation of the unit with compressor jackets and insulating material made with high density media and the interposition of heavy bitumen layer.

3.2.7 SLN version

SLN versions are supplied, as standard, with the latest 'Floating Frame' technology that completely isolates the compressors from the main casing, thereby eliminating vibration and noise from this source. The 'Floating Frame' is a special vibration and acoustic damping system that consists of a base plate and acoustic enclosure that houses the compressors. The base plate is separated from the supporting frame of the unit by soft steel springs that have a high damping power. Within the enclosure, the compressors are mounted on rubber shock absorbers on the floating base plate. The enclosure is manufactured from galvanized steel sandwich panels that have a micro-perforated inner skin and a core of 25 mm thick, high density (4 kg/m²) mineral wool. The entire arrangement provides a double damping system and acoustic attenuation. The compressor refrigerant pipes are connected to the refrigerant circuit through "anaconda" flexible connections. Flexible connections are also used on the water pipework within the unit. The combination of these systems results in an overall noise reduction in the region of 10-12 dB(A).

3.2.8 DHW Version

This is a two pipe version that can, in addition to producing hot water for heating and cold water for cooling, also generate domestic hot water. The controller has dual heating set points (heating and DHW) and can also control a three port diverting valve that directs the DHW to the cylinder. DHW production has priority irrespective of the mode of operation of the unit. The unit is normally used with two pipe water based change-over systems.

3.3 Accessories description

3.3.1 Condensate discharge drip tray with antifreeze heater

Installed under the finned heat exchanger, this is used to collect the condensate generated during the heating mode operation. It is fitted with trace heating to prevent ice formation in low ambient conditions. This accessory may only be factory fitted.

3.3.2 Antifreeze kit

This kit, used on units fitted with a hydraulic kit, comprises a “self-heating” electric cable that is wrapped around the user exchanger and the water circuit pipework. This device is controlled by the microprocessor.

3.3.3 Rubber vibration dampers

To be installed beneath the unit base and the ground to avoid the transmission of vibrations (and the noise) to the building.

3.3.4 RS485 serial interface card modbus protocol

This controller card enables the controller to communicate with other devices on a BMS using Modbus protocol.

3.3.5 High efficiency E.C. axial fans

High efficiency E.C. axial fans, supplied with Brushless DC electric motors electronically commutated (E.C. motors) able to grant the highest energy efficiency class (EFF1), according to the latest EU specifications, with the result of substantial energy consumption reduction for ventilation and noise reduction thanks to the new ultra efficient blade profiling. The fans are statically and dynamically balanced and supplied complete with a safety fan guard complying with the requirements of EN 60335. The fans are installed using a special steel profiled beam who minimize all vibrations and noise emitted. The nominal rotation speed is 700 rpm. All units are fitted with a pressure transducer for the control of the evaporation/condensation pressure. All electric motors are fitted with integrated thermal overload protection rating IP54.

3.3.6 Electronic expansion valve

The electronic expansion valve enables the maximum possible efficiency to be achieved by maximising the evaporator heat exchange, minimising the reaction time to load variations and optimising the superheat. It is strongly recommended for use in systems that will experience large load variations.

3.3.7 Electronic soft starter

All units are supplied, standard with the soft starter device who minimize the peak starting current of the compressor reducing down to the same value of the nominal maximum input current.

3.3.8 Remote control panel

All units are supplied with microprocessor control panel with high definition display, mounted on board of the unit and it is remotable up to 50 mt. distance.

3.3.9 Hydraulic circuit antifreeze kit

This kit, used on units fitted with a hydraulic kit, comprises a “self-heating” electric cable that is wrapped around the user and domestic hot water exchanger (P4 Units only), the water circuit pipework and includes an armoured electric heater that is fitted inside the water tank. This device is controlled by the microprocessor and it is used in the unit equipped with hydraulic kit.

3.3.10 Integrated hydraulic kit 1 pump + Water tank

It includes: Water tank in different sizes (depending on the size of the unit) factory insulated with flexible close cell material and prepared for the installation of an antifreeze kit (option) and 1 water pump, centrifugal type, suitable for chilled water operation. The pumps are directly controlled by the microprocessor. The water tank is installed on the outlet water side in order to minimize fluctuations in the water temperature due to the compressors cycling at part load conditions. Also provided in the hydraulic circuit are an expansion vessel, pressure relief valve and system isolating valves with fittings.

3.3.11 Integrated hydraulic kit 2 pumps + Water tank

It includes: Water tank in different sizes (depending on the size of the unit) factory insulated with flexible close cell material and prepared for

the installation of an antifreeze kit (option) and 2 pumps running+stand-by, centrifugal type, suitable for chilled water operation. The pumps are directly controlled by the microprocessor. The water tank is installed on the outlet water side in order to minimize fluctuations in the water temperature due to the compressors cycling at part load conditions. Also provided in the hydraulic circuit are an expansion vessel, pressure relief valve and system isolating valves with fittings.

3.3.12 Hydraulic kit with one pump without tank - user circuit

It includes: 1 water pump, pressure relief valve (if required by PED norms).

3.3.13 Hydraulic kit with two pumps without tank - user circuit

It includes: 2 pumps running+stand-by, pressure relief valve (if required by PED norms).

3.3.14 Cascade control system

Cascade control system for the management of units. The system is made of a separate plastic box, to be installed in the technical room. It is connected to the units via RS485.

3.4 Technical data

Heating only version

SE/ACF		22	30	40	45	50	60	70	75	90	105	115	140
Heating capacity (EN14511) ⁽¹⁾	kW	22,0	28,7	34,5	47,2	50,9	56,8	64,9	73,2	80,2	97,0	105,7	122,3
Total input power (EN14511) ⁽¹⁾	kW	5,8	7,3	9,1	12,2	12,6	14,4	16,0	17,9	20,8	24,3	27,3	30,7
COP (EN14511) ⁽¹⁾	W/W	3,83	3,93	3,80	3,86	4,04	3,94	4,06	4,10	3,86	4,00	3,87	3,98
Energy Class ⁽²⁾		A+	A+	A+	A+	A+	A+	A+	A+	A+	A+	A+	A+
SCOP ⁽²⁾	kWh/kWh	3,27	3,58	3,41	3,34	3,48	3,54	3,43	3,47	3,42	3,50	3,39	3,50
η _{s,h} ⁽²⁾	%	127,9	140,1	133,3	130,4	136,3	138,6	134,3	135,9	133,7	137,1	132,7	136,9
Sound power level ⁽³⁾	dB (A)	75	75	75	75	77	77	77	78	79	82	83	85
Sound pressure level ⁽⁴⁾	dB (A)	43	43	43	43	45	45	45	46	47	50	51	53
SE		22	30	40	45	50	60	70	75	90	105	115	140
Heating capacity (EN14511) ⁽¹⁾	kW	21,9	28,6	34,2	47,1	51,1	57,1	64,9	73,1	81,0	97,0	105,6	122,7
Total input power (EN14511) ⁽¹⁾	kW	5,6	7,2	8,8	11,9	12,4	14,4	15,8	17,6	20,9	24,0	27,3	30,5
COP (EN14511) ⁽¹⁾	W/W	3,92	3,95	3,87	3,95	4,13	3,97	4,10	4,15	3,88	4,04	3,87	4,02
Energy Class ⁽²⁾		A+	A+	A+	A+	A+	A+	A+	A+	A+	A+	A+	A+
SCOP ⁽²⁾	kWh/kWh	3,40	3,66	3,53	3,46	3,59	3,62	3,68	3,71	3,63	3,71	3,64	3,73
η _{s,h} ⁽²⁾	%	132,8	143,2	138,3	135,5	140,4	141,7	144,1	145,4	142,1	145,3	142,5	146,1
Sound power level ⁽³⁾	dB (A)	74	74	75	75	77	77	77	78	79	82	83	85
Sound pressure level ⁽⁴⁾	dB (A)	42	42	43	43	45	45	45	46	47	50	51	53
Power supply	V/Ph/Hz	400/3+N/50	400/3+N/50	400/3+N/50	400/3/50	400/3/50	400/3/50	400/3/50	400/3/50	400/3/50	400/3/50	400/3/50	400/3/50
Compressors / Circuits	n° / n°	2 / 1	2 / 1	2 / 1	2 / 1	2 / 1	2 / 1	2 / 1	2 / 1	2 / 1	2 / 1	2 / 1	2 / 1
Fans	n°	2	2	2	2	2	2	2	2	2	3	3	3
Refrigerant		R410A	R410A	R410A	R410A	R410A	R410A	R410A	R410A	R410A	R410A	R410A	R410A
Refrigerant charge	Kg	5,5	5,7	6,9	8,3	8,4	9,3	11,9	14,6	14,9	17,4	17,4	22,1
Global warming potential (GWP)		2088	2088	2088	2088	2088	2088	2088	2088	2088	2088	2088	2088
Equivalent CO ₂ charge	t	11,5	11,8	14,5	17,2	17,5	19,5	24,8	30,5	31,1	36,3	36,3	46,1
SE/ACF		150	170	180	210	240	230	270	300	340	365	410	465
Heating capacity (EN14511) ⁽¹⁾	kW	136,0	157,3	169,0	196,6	215,0	211,8	226,1	258,8	330,6	357,4	393,3	431,7
Total input power (EN14511) ⁽¹⁾	kW	34,6	40,3	43,4	51,5	60,4	58,2	64,8	71,9	85,2	93,8	103,0	116,4
COP (EN14511) ⁽¹⁾	W/W	3,93	3,90	3,89	3,82	3,56	3,64	3,49	3,60	3,88	3,81	3,82	3,71
Energy Class ⁽²⁾		A+	A+	A+	A+	A+	A+	A+	A+	A+	A+	A+	A+
SCOP ⁽²⁾	kWh/kWh	3,50	3,48	3,46	3,45	3,24	3,25	3,23	3,26	3,25	3,27	3,24	3,34
η _{s,h} ⁽²⁾	%	137,0	136,1	135,5	134,8	126,5	127,1	126,1	127,2	127,0	127,8	126,4	130,4
Sound power level ⁽³⁾	dB (A)	86	86	86	89	90	87	89	90	90	90	92	93
Sound pressure level ⁽⁴⁾	dB (A)	54	54	54	57	58	55	57	58	58	58	60	61
SE		150	170	180	210	240	230	270	300	340	365	410	465
Heating capacity (EN14511) ⁽¹⁾	kW	137,0	157,8	170,2	197,7	217,6	213,2	227,7	261,7	330,6	357,5	396,6	435,4
Total input power (EN14511) ⁽¹⁾	kW	34,6	38,8	43,3	51,5	60,3	57,9	65,1	71,9	82,9	92,1	102,7	116,7
COP (EN14511) ⁽¹⁾	W/W	3,96	4,07	3,93	3,84	3,61	3,68	3,50	3,64	3,99	3,88	3,86	3,73
Energy Class ⁽²⁾		A+	A+	A+	A+	A+	A+	A+	A+	A+	A+	A+	A+
SCOP ⁽²⁾	kWh/kWh	3,68	3,77	3,72	3,74	3,63	3,54	3,49	3,46	3,52	3,57	3,63	3,58
η _{s,h} ⁽²⁾	%	144,0	147,8	145,8	146,4	142,1	138,6	136,5	135,2	137,9	139,6	142,3	140,0
Sound power level ⁽³⁾	dB (A)	86	86	86	89	90	87	89	90	90	90	92	93
Sound pressure level ⁽⁴⁾	dB (A)	54	54	54	57	58	55	57	58	58	58	60	61
Power supply	V/Ph/Hz	400/3/50	400/3/50	400/3/50	400/3/50	400/3/50	400/3/50	400/3/50	400/3/50	400/3/50	400/3/50	400/3/50	400/3/50
Compressors / Circuits	n° / n°	2 / 1	2 / 1	2 / 1	2 / 1	2 / 1	4 / 2	4 / 2	4 / 2	4 / 2	4 / 2	4 / 2	4 / 2
Fans	n°	4	4	4	3	4	4	4	4	6	6	6	8
Refrigerant		R410A	R410A	R410A	R410A	R410A	R410A	R410A	R410A	R410A	R410A	R410A	R410A
Refrigerant charge	Kg	22,3	29,5	29,8	34,9	35,4	41	41,5	47,5	68,7	69,6	80,3	82,7
Global warming potential (GWP)		2088	2088	2088	2088	2088	2088	2088	2088	2088	2088	2088	2088
Equivalent CO ₂ charge	t	46,6	61,6	62,2	72,9	73,9	85,6	86,7	99,2	143,4	145,3	167,7	172,7

Performances are referred to the following conditions:

(1) Heating: Ambient temperature 7°C DB, 6°C WB, water temperature 30/35°C.

(2) Average conditions, low temperature, variable - Reg EU 811/2013

(3) Sound power level in accordance with ISO 3744.

(4) Sound pressure level at 10 mt from the unit in free field conditions in accordance with ISO 3744.



The refrigerant data may change without notice. It is therefore necessary to refer always to the silver label placed on the unit.

Heating only version

ACF		22	30	40	45	50	60	70	75	90	105	115	140
Heating capacity (EN14511) ⁽¹⁾	kW	22,2	29,6	37,3	46,9	50,7	61,2	67,3	72,6	93,1	104,7	114,4	137,2
Total input power (EN14511) ⁽¹⁾	kW	5,3	7,1	9,0	11,4	12,0	13,6	15,4	17,0	22,1	25,3	28,4	32,4
COP (EN14511) ⁽¹⁾	W/W	4,11	4,12	4,13	4,11	4,22	4,49	4,38	4,27	4,21	4,14	4,03	4,24
Energy Class ⁽²⁾		A+	A+	A+	A+	A+	A++	A++	A++	A+	A+	A+	A+
SCOP ⁽²⁾	kWh/kWh	3,40	3,69	3,53	3,57	3,67	3,97	3,91	3,87	3,70	3,67	3,69	3,70
η _{s,h} ⁽²⁾	%	132,9	144,7	138,0	139,6	143,8	155,7	153,4	151,6	145,1	143,7	144,4	144,8
Sound power level ⁽³⁾	dB (A)	75	75	75	75	76	76	77	78	82	83	85	86
Sound pressure level ⁽⁴⁾	dB (A)	43	43	43	43	44	44	45	46	50	51	53	54
STANDARD		22	30	40	45	50	60	70	75	90	105	115	140
Heating capacity (EN14511) ⁽¹⁾	kW	22,2	29,6	37,3	47,1	50,8	61,2	67,3	74,9	93,2	104,9	114,9	137,1
Total input power (EN14511) ⁽¹⁾	kW	5,3	7,1	8,8	11,5	11,8	13,3	15,1	17,2	21,2	24,5	27,8	30,9
COP (EN14511) ⁽¹⁾	W/W	4,11	4,16	4,23	4,11	4,32	4,61	4,46	4,36	4,40	4,29	4,13	4,44
Energy Class ⁽²⁾		A++	A++	A++	A++	A++	A++	A++	A++	A++	A++	A++	A++
SCOP ⁽²⁾	kWh/kWh	3,83	3,86	3,85	3,85	3,92	4,13	4,04	3,97	3,87	3,85	3,83	3,85
η _{s,h} ⁽²⁾	%	150,1	151,4	150,9	151,1	153,6	162,0	158,4	155,8	151,7	150,8	150,2	151,0
Sound power level ⁽³⁾	dB (A)	73	74	74	75	76	76	77	78	82	83	85	86
Sound pressure level ⁽⁴⁾	dB (A)	41	42	42	43	44	44	45	46	50	51	53	54
Power supply	V/Ph/Hz	400/3+N/50	400/3+N/50	400/3/50	400/3/50	400/3/50	400/3/50	400/3/50	400/3/50	400/3/50	400/3/50	400/3/50	400/3/50
Compressors / Circuits	n° / n°	2 / 1	2 / 1	2 / 1	2 / 1	2 / 1	2 / 1	2 / 1	2 / 1	2 / 1	2 / 1	2 / 1	2 / 1
Fans	n°	2	2	2	2	2	2	2	2	2	2	2	3
Refrigerant		R410A	R410A	R410A	R410A	R410A	R410A	R410A	R410A	R410A	R410A	R410A	R410A
Refrigerant charge	Kg	7,7	7,7	10,6	10,9	11,1	14,8	14,9	15,2	22,5	22,5	22,5	34,4
Global warming potential (GWP)		2088	2088	2088	2088	2088	2088	2088	2088	2088	2088	2088	2088
Equivalent CO ₂ charge	t	16,1	16,1	22,1	22,7	23,2	30,9	31,1	31,7	47,0	47,0	47,0	71,8

ACF		150	170	180	210	240	230	270	300	340	365	410	465
Heating capacity (EN14511) ⁽¹⁾	kW	150,8	167,2	182,0	209,7	239,2	228,6	270,2	295,6	335,0	363,1	404,5	458,7
Total input power (EN14511) ⁽¹⁾	kW	35,8	41,3	45,4	50,3	55,8	56,7	67,0	74,1	83,5	90,3	105,1	116,4
COP (EN14511) ⁽¹⁾	W/W	4,21	4,05	4,01	4,17	4,29	4,03	4,03	3,99	4,01	4,02	3,85	3,94
Energy Class ⁽²⁾		A+	A+	A+	A+	A++	A+	A+	A+	A+	A+	A+	A+
SCOP ⁽²⁾	kWh/kWh	3,74	3,69	3,62	3,76	3,83	3,65	3,63	3,65	3,66	3,73	3,61	3,63
η _{s,h} ⁽²⁾	%	146,4	144,7	141,9	147,3	150,3	143,1	142,0	142,9	143,3	146,1	141,4	142,0
Sound power level ⁽³⁾	dB (A)	87	87	87	89	91	88	89	90	90	90	92	92
Sound pressure level ⁽⁴⁾	dB (A)	55	55	55	57	59	56	57	58	58	58	60	60
STANDARD		150	170	180	210	240	230	270	300	340	365	410	465
Heating capacity (EN14511) ⁽¹⁾	kW	151,0	167,9	182,8	210,6	241,3	229,4	271,4	296,7	339,0	364,9	407,0	463,7
Total input power (EN14511) ⁽¹⁾	kW	34,4	40,2	45,5	49,4	54,8	55,8	63,9	71,5	83,7	88,8	104,1	115,1
COP (EN14511) ⁽¹⁾	W/W	4,39	4,18	4,02	4,26	4,40	4,11	4,25	4,15	4,05	4,11	3,91	4,03
Energy Class ⁽²⁾		A++	A++	A++	A++	A++	A++	A++	A++	A++	A++	A++	A++
SCOP ⁽²⁾	kWh/kWh	3,86	3,85	3,84	3,92	3,97	3,83	3,85	3,83	3,91	3,89	3,87	3,86
η _{s,h} ⁽²⁾	%	151,3	150,9	150,4	153,6	155,6	150,2	151,1	150,3	153,5	152,4	151,9	151,5
Sound power level ⁽³⁾	dB (A)	87	87	87	89	91	88	89	90	90	90	92	92
Sound pressure level ⁽⁴⁾	dB (A)	55	55	55	57	59	56	57	58	58	58	60	60
Power supply	V/Ph/Hz	400/3/50	400/3/50	400/3/50	400/3/50	400/3/50	400/3/50	400/3/50	400/3/50	400/3/50	400/3/50	400/3/50	400/3/50
Compressors / Circuits	n° / n°	2 / 1	2 / 1	2 / 1	2 / 1	2 / 1	4 / 2	4 / 2	4 / 2	4 / 2	4 / 2	4 / 2	4 / 2
Fans	n°	3	3	3	3	3	4	6	6	6	6	8	8
Refrigerant		R410A	R410A	R410A	R410A	R410A	R410A	R410A	R410A	R410A	R410A	R410A	R410A
Refrigerant charge	Kg	34,8	35,3	35,3	49,4	57,3	56,7	66,5	67,1	68,0	79,9	81,1	97,7
Global warming potential (GWP)		2088	2088	2088	2088	2088	2088	2088	2088	2088	2088	2088	2088
Equivalent CO ₂ charge	t	72,7	73,7	73,7	103,1	119,6	118,4	138,9	140,1	142,0	166,8	169,3	204,0

Performances are referred to the following conditions:

(1) Heating: Ambient temperature 7°C DB, 6°C WB, water temperature 30/35°C.

(2) Average conditions, low temperature, variable - Reg EU 811/2013

(3) Sound power level in accordance with ISO 3744.

(4) Sound pressure level at 10 mt from the unit in free field conditions in accordance with ISO 3744.



The refrigerant data may change without notice. It is therefore necessary to refer always to the silver label placed on the unit.

Reversible heating/cooling version (RV)

SE/ACF/RV		22	30	40	45	50	60	70	75	90	105	115	140
Heating capacity (EN14511) ⁽¹⁾	kW	22,0	28,7	34,5	47,2	50,9	56,8	64,9	73,2	80,2	97,0	105,7	122,3
Total input power (EN14511) ⁽¹⁾	kW	5,8	7,3	9,1	12,2	12,6	14,4	16,0	17,9	20,8	24,3	27,3	30,7
COP (EN14511) ⁽¹⁾	W/W	3,83	3,93	3,80	3,86	4,04	3,94	4,06	4,10	3,86	4,00	3,87	3,98
Energy Class ⁽²⁾		A+	A+	A+	A+	A+	A+	A+	A+	A+	A+	A+	A+
SCOP ⁽²⁾	kWh/kWh	3,27	3,58	3,41	3,34	3,48	3,54	3,43	3,47	3,42	3,50	3,39	3,50
η _{s,h} ⁽²⁾	%	127,9	140,1	133,3	130,4	136,3	138,6	134,3	135,9	133,7	137,1	132,7	136,9
Cooling capacity (EN14511) ⁽³⁾	kW	17,8	24,1	28,4	38,8	42,7	48,2	55,2	60,2	69,7	83,3	91,6	102,6
Total input power (EN14511) ⁽³⁾	kW	7,1	9,8	11,7	15,0	16,4	19,8	21,9	24,5	29,3	32,7	37,7	42,6
EER (EN14511) ⁽³⁾	W/W	2,52	2,45	2,42	2,58	2,61	2,43	2,52	2,46	2,38	2,55	2,43	2,41
Sound power level ⁽⁴⁾	dB (A)	75	75	75	75	77	77	77	78	79	82	83	85
Sound pressure level ⁽⁵⁾	dB (A)	43	43	43	43	45	45	45	46	47	50	51	53

SE/RV		22	30	40	45	50	60	70	75	90	105	115	140
Heating capacity (EN14511) ⁽¹⁾	kW	21,9	28,6	34,2	47,1	51,1	57,1	64,9	73,1	81,0	97,0	105,6	122,7
Total input power (EN14511) ⁽¹⁾	kW	5,6	7,2	8,8	11,9	12,4	14,4	15,8	17,6	20,9	24,0	27,3	30,5
COP (EN14511) ⁽¹⁾	W/W	3,92	3,95	3,87	3,95	4,13	3,97	4,10	4,15	3,88	4,04	3,87	4,02
Energy Class ⁽²⁾		A+	A+	A+	A+	A+	A+	A+	A+	A+	A+	A+	A+
SCOP ⁽²⁾	kWh/kWh	3,40	3,66	3,53	3,46	3,59	3,62	3,68	3,71	3,63	3,71	3,64	3,73
η _{s,h} ⁽²⁾	%	132,8	143,2	138,3	135,5	140,4	141,7	144,1	145,4	142,1	145,3	142,5	146,1
Cooling capacity (EN14511) ⁽³⁾	kW	17,7	24,1	28,2	39,0	43,5	48,9	55,6	61,3	70,3	84,3	92,0	103,5
Total input power (EN14511) ⁽³⁾	kW	7,0	9,8	11,8	14,9	16,0	19,5	21,8	24,0	28,9	32,3	37,4	42,2
EER (EN14511) ⁽³⁾	W/W	2,52	2,47	2,40	2,61	2,72	2,51	2,55	2,55	2,43	2,61	2,46	2,45
Sound power level ⁽⁴⁾	dB (A)	74	74	75	75	77	77	77	78	79	82	83	85
Sound pressure level ⁽⁵⁾	dB (A)	42	42	43	43	45	45	45	46	47	50	51	53
Power supply	V/Ph/Hz	400/3+N/50	400/3+N/50	400/3+N/50	400/3/50	400/3/50	400/3/50	400/3/50	400/3/50	400/3/50	400/3/50	400/3/50	400/3/50
Compressors / Circuits	n° / n°	2 / 1	2 / 1	2 / 1	2 / 1	2 / 1	2 / 1	2 / 1	2 / 1	2 / 1	2 / 1	2 / 1	2 / 1
Fans	n°	2	2	2	2	2	2	2	2	2	3	3	3
Refrigerant		R410A	R410A	R410A	R410A	R410A	R410A	R410A	R410A	R410A	R410A	R410A	R410A
Refrigerant charge	Kg	5,5	5,7	6,9	8,3	8,4	9,3	11,9	14,6	14,9	17,4	17,4	22,1
Global warming potential (GWP)		2088	2088	2088	2088	2088	2088	2088	2088	2088	2088	2088	2088
Equivalent CO ₂ charge	t	11,5	11,8	14,5	17,2	17,5	19,5	24,8	30,5	31,1	36,3	36,3	46,1

SE/ACF/RV		150	170	180	210	240	230	270	300	340	365	410	465
Heating capacity (EN14511) ⁽¹⁾	kW	136,0	157,3	169,0	196,6	215,0	211,8	226,1	258,8	330,6	357,4	393,3	431,7
Total input power (EN14511) ⁽¹⁾	kW	34,6	40,3	43,4	51,5	60,4	58,2	64,8	71,9	85,2	93,8	103,0	116,4
COP (EN14511) ⁽¹⁾	W/W	3,93	3,90	3,89	3,82	3,56	3,64	3,49	3,60	3,88	3,81	3,82	3,71
Energy Class ⁽²⁾		A+	A+	A+	A+	A+	A+	A+	A+	A+	A+	A+	A+
SCOP ⁽²⁾	kWh/kWh	3,50	3,48	3,46	3,45	3,24	3,25	3,23	3,26	3,25	3,27	3,24	3,34
η _{s,h} ⁽²⁾	%	137,0	136,1	135,5	134,8	126,5	127,1	126,1	127,2	127,0	127,8	126,4	130,4
Cooling capacity (EN14511) ⁽³⁾	kW	115,6	131,9	143,0	173,0	197,2	192,3	210,8	231,8	286,3	312,9	349,4	401,8
Total input power (EN14511) ⁽³⁾	kW	47,2	53,8	63,6	68,9	76,7	76,0	87,5	97,8	106,0	121,8	138,1	153,4
EER (EN14511) ⁽³⁾	W/W	2,45	2,45	2,25	2,51	2,57	2,53	2,41	2,37	2,70	2,57	2,53	2,62
Sound power level ⁽⁴⁾	dB (A)	86	86	86	89	90	87	89	90	90	90	92	93
Sound pressure level ⁽⁵⁾	dB (A)	54	54	54	57	58	55	57	58	58	58	60	61

SE/RV		150	170	180	210	240	230	270	300	340	365	410	465
Heating capacity (EN14511) ⁽¹⁾	kW	137,0	157,8	170,2	197,7	217,6	213,2	227,7	261,7	330,6	357,5	396,6	435,4
Total input power (EN14511) ⁽¹⁾	kW	34,6	38,8	43,3	51,5	60,3	57,9	65,1	71,9	82,9	92,1	102,7	116,7
COP (EN14511) ⁽¹⁾	W/W	3,96	4,07	3,93	3,84	3,61	3,68	3,50	3,64	3,99	3,88	3,86	3,73
Energy Class ⁽²⁾		A+	A+	A+	A+	A+	A+	A+	A+	A+	A+	A+	A+
SCOP ⁽²⁾	kWh/kWh	3,68	3,77	3,72	3,74	3,63	3,54	3,49	3,46	3,52	3,57	3,63	3,58
η _{s,h} ⁽²⁾	%	144,0	147,8	145,8	146,4	142,1	138,6	136,5	135,2	137,9	139,6	142,3	140,0
Cooling capacity (EN14511) ⁽³⁾	kW	116,4	132,9	147,1	175,3	200,4	195,8	212,1	233,3	289,3	321,1	357,3	408,0
Total input power (EN14511) ⁽³⁾	kW	46,9	53,4	61,0	67,9	75,6	74,4	86,9	96,8	104,8	118,1	135,9	150,0
EER (EN14511) ⁽³⁾	W/W	2,48	2,49	2,41	2,58	2,65	2,63	2,44	2,41	2,76	2,72	2,63	2,72
Sound power level ⁽⁴⁾	dB (A)	86	86	86	89	90	87	89	90	90	90	92	93
Sound pressure level ⁽⁵⁾	dB (A)	54	54	54	57	58	55	57	58	58	58	60	61
Power supply	V/Ph/Hz	400/3/50	400/3/50	400/3/50	400/3/50	400/3/50	400/3/50	400/3/50	400/3/50	400/3/50	400/3/50	400/3/50	400/3/50
Compressors / Circuits	n° / n°	2 / 1	2 / 1	2 / 1	2 / 1	2 / 1	4 / 2	4 / 2	4 / 2	4 / 2	4 / 2	4 / 2	4 / 2
Fans	n°	4	4	4	3	4	4	4	4	6	6	6	8
Refrigerant		R410A	R410A	R410A	R410A	R410A	R410A	R410A	R410A	R410A	R410A	R410A	R410A
Refrigerant charge	Kg	22,3	29,5	29,8	34,9	35,4	41	41,5	47,5	68,7	69,6	80,3	82,7
Global warming potential (GWP)		2088	2088	2088	2088	2088	2088	2088	2088	2088	2088	2088	2088
Equivalent CO ₂ charge	t	46,6	61,6	62,2	72,9	73,9	85,6	86,7	99,2	143,4	145,3	167,7	172,7

Performances are referred to the following conditions:

(1) Heating: Ambient temperature 7°C DB, 6°C WB, water temperature 30/35°C.

(2) Average conditions, low temperature, variable - Reg EU 811/2013

(3) Cooling: ambient air temperature 35°C, evaporator water temperature in/out 12/7 °C..

(4) Sound power level in accordance with ISO 3744..

(5) Sound pressure level at 10 mt from the unit in free field conditions in accordance with ISO 3744.



The refrigerant data may change without notice. It is therefore necessary to refer always to the silver label placed on the unit.

Reversible heating/cooling version (RV)

ACF/RV		22	30	40	45	50	60	70	75	90	105	115	140
Heating capacity (EN14511) ⁽¹⁾	kW	22,2	29,6	37,3	46,9	50,7	61,2	67,3	72,6	93,1	104,7	114,4	137,2
Total input power (EN14511) ⁽¹⁾	kW	5,3	7,1	9,0	11,4	12,0	13,6	15,4	17,0	22,1	25,3	28,4	32,4
COP (EN14511) ⁽¹⁾	W/W	4,11	4,12	4,13	4,11	4,22	4,49	4,38	4,27	4,21	4,14	4,03	4,24
Energy Class ⁽²⁾		A+	A+	A+	A+	A+	A++	A++	A++	A+	A+	A+	A+
SCOP ⁽²⁾	kWh/kWh	3,40	3,69	3,53	3,57	3,67	3,97	3,91	3,87	3,70	3,67	3,69	3,70
η _{s,h} ⁽²⁾	%	132,9	144,7	138,0	139,6	143,8	155,7	153,4	151,6	145,1	143,7	144,4	144,8
Cooling capacity (EN14511) ⁽³⁾	kW	18,1	24,5	30,8	39,9	44,2	52,3	57,4	62,6	79,8	89,6	97,8	117,0
Total input power (EN14511) ⁽³⁾	kW	7,0	9,6	10,9	15,0	16,3	18,4	21,5	24,5	27,2	31,7	36,5	43,8
EER (EN14511) ⁽³⁾	W/W	2,57	2,56	2,84	2,65	2,72	2,84	2,67	2,55	2,93	2,83	2,68	2,67
Sound power level ⁽⁴⁾	dB (A)	75	75	75	75	76	76	77	78	82	83	85	86
Sound pressure level ⁽⁵⁾	dB (A)	43	43	43	43	44	44	45	46	50	51	53	54
RV		22	30	40	45	50	60	70	75	90	105	115	140
Heating capacity (EN14511) ⁽¹⁾	kW	22,2	29,6	37,3	47,1	50,8	61,2	67,3	74,9	93,2	104,9	114,9	137,1
Total input power (EN14511) ⁽¹⁾	kW	5,3	7,1	8,8	11,5	11,8	13,3	15,1	17,2	21,2	24,5	27,8	30,9
COP (EN14511) ⁽¹⁾	W/W	4,11	4,16	4,23	4,11	4,32	4,61	4,46	4,36	4,40	4,29	4,13	4,44
Energy Class ⁽²⁾		A++	A++	A++	A++	A++	A++	A++	A++	A++	A++	A++	A++
SCOP ⁽²⁾	kWh/kWh	3,83	3,86	3,85	3,85	3,92	4,13	4,04	3,97	3,87	3,85	3,83	3,85
η _{s,h} ⁽²⁾	%	150,1	151,4	150,9	151,1	153,6	162,0	158,4	155,8	151,7	150,8	150,2	151,0
Cooling capacity (EN14511) ⁽³⁾	kW	18,1	24,6	30,5	40,6	44,2	52,4	57,5	63,4	80,5	90,2	100,5	117,4
Total input power (EN14511) ⁽³⁾	kW	6,9	9,5	11,0	14,5	16,1	18,3	21,3	23,9	26,6	31,2	35,1	38,6
EER (EN14511) ⁽³⁾	W/W	2,62	2,59	2,78	2,81	2,74	2,87	2,70	2,65	3,03	2,89	2,86	3,04
Sound power level ⁽⁴⁾	dB (A)	73	74	74	75	76	76	77	78	82	83	85	86
Sound pressure level ⁽⁵⁾	dB (A)	41	42	42	43	44	44	45	46	50	51	53	54
Power supply	V/Ph/Hz	400/3+N/50	400/3+N/50	400/3/50	400/3/50	400/3/50	400/3/50	400/3/50	400/3/50	400/3/50	400/3/50	400/3/50	400/3/50
Compressors / Circuits	n° / n°	2 / 1	2 / 1	2 / 1	2 / 1	2 / 1	2 / 1	2 / 1	2 / 1	2 / 1	2 / 1	2 / 1	2 / 1
Fans	n°	2	2	2	2	2	2	2	2	2	2	2	3
Refrigerant		R410A	R410A	R410A	R410A	R410A	R410A	R410A	R410A	R410A	R410A	R410A	R410A
Refrigerant charge	Kg	7,7	7,7	10,6	10,9	11,1	14,8	14,9	15,2	22,5	22,5	22,5	34,4
Global warming potential (GWP)		2088	2088	2088	2088	2088	2088	2088	2088	2088	2088	2088	2088
Equivalent CO ₂ charge	t	16,1	16,1	22,1	22,7	23,2	30,9	31,1	31,7	47,0	47,0	47,0	71,8

ACF/RV		150	170	180	210	240	230	270	300	340	365	410	465
Heating capacity (EN14511) ⁽¹⁾	kW	150,8	167,2	182,0	209,7	239,2	228,6	270,2	295,6	335,0	363,1	404,5	458,7
Total input power (EN14511) ⁽¹⁾	kW	35,8	41,3	45,4	50,3	55,8	56,7	67,0	74,1	83,5	90,3	105,1	116,4
COP (EN14511) ⁽¹⁾	W/W	4,21	4,05	4,01	4,17	4,29	4,03	4,03	3,99	4,01	4,02	3,85	3,94
Energy Class ⁽²⁾		A+	A+	A+	A+	A++	A+	A+	A+	A+	A+	A+	A+
SCOP ⁽²⁾	kWh/kWh	3,74	3,69	3,62	3,76	3,83	3,65	3,63	3,65	3,66	3,73	3,61	3,63
η _{s,h} ⁽²⁾	%	146,4	144,7	141,9	147,3	150,3	143,1	142,0	142,9	143,3	146,1	141,4	142,0
Cooling capacity (EN14511) ⁽³⁾	kW	129,5	144,5	159,3	180,2	199,7	197,4	230,1	257,2	288,2	325,6	366,0	405,0
Total input power (EN14511) ⁽³⁾	kW	44,3	51,8	58,8	66,3	74,5	73,1	81,9	91,5	105,6	116,7	136,1	155,2
EER (EN14511) ⁽³⁾	W/W	2,92	2,79	2,71	2,72	2,68	2,70	2,81	2,81	2,73	2,79	2,69	2,61
Sound power level ⁽⁴⁾	dB (A)	87	87	87	89	91	88	89	90	90	90	92	92
Sound pressure level ⁽⁵⁾	dB (A)	55	55	55	57	59	56	57	58	58	58	60	60
RV		150	170	180	210	240	230	270	300	340	365	410	465
Heating capacity (EN14511) ⁽¹⁾	kW	151,0	167,9	182,8	210,6	241,3	229,4	271,4	296,7	339,0	364,9	407,0	463,7
Total input power (EN14511) ⁽¹⁾	kW	34,4	40,2	45,5	49,4	54,8	55,8	63,9	71,5	83,7	88,8	104,1	115,1
COP (EN14511) ⁽¹⁾	W/W	4,39	4,18	4,02	4,26	4,40	4,11	4,25	4,15	4,05	4,11	3,91	4,03
Energy Class ⁽²⁾		A++	A++	A++	A++	A++	A++	A++	A++	A++	A++	A++	A++
SCOP ⁽²⁾	kWh/kWh	3,86	3,85	3,84	3,92	3,97	3,83	3,85	3,83	3,91	3,89	3,87	3,86
η _{s,h} ⁽²⁾	%	151,3	150,9	150,4	153,6	155,6	150,2	151,1	150,3	153,5	152,4	151,9	151,5
Cooling capacity (EN14511) ⁽³⁾	kW	129,5	146,8	159,2	180,4	202,1	198,5	231,0	259,7	289,4	322,6	368,5	416,0
Total input power (EN14511) ⁽³⁾	kW	44,0	50,8	58,7	66,1	73,2	72,7	80,5	89,2	105,2	118,2	135,0	154,6
EER (EN14511) ⁽³⁾	W/W	2,94	2,89	2,71	2,73	2,76	2,73	2,87	2,91	2,75	2,73	2,73	2,69
Sound power level ⁽⁴⁾	dB (A)	87	87	87	89	91	88	89	90	90	90	92	92
Sound pressure level ⁽⁵⁾	dB (A)	55	55	55	57	59	56	57	58	58	58	60	60
Power supply	V/Ph/Hz	400/3/50	400/3/50	400/3/50	400/3/50	400/3/50	400/3/50	400/3/50	400/3/50	400/3/50	400/3/50	400/3/50	400/3/50
Compressors / Circuits	n° / n°	2 / 1	2 / 1	2 / 1	2 / 1	2 / 1	4 / 2	4 / 2	4 / 2	4 / 2	4 / 2	4 / 2	4 / 2
Fans	n°	3	3	3	3	3	4	6	6	6	6	8	8
Refrigerant		R410A	R410A	R410A	R410A	R410A	R410A	R410A	R410A	R410A	R410A	R410A	R410A
Refrigerant charge	Kg	34,8	35,3	35,3	49,4	57,3	56,7	66,5	67,1	68,0	79,9	81,1	97,7
Global warming potential (GWP)		2088	2088	2088	2088	2088	2088	2088	2088	2088	2088	2088	2088
Equivalent CO ₂ charge	t	72,7	73,7	73,7	103,1	119,6	118,4	138,9	140,1	142,0	166,8	169,3	204,0

Performances are referred to the following conditions:

(1) Heating: Ambient temperature 7°C DB, 6°C WB, water temperature 30/35°C.

(2) Average conditions, low temperature, variable - Reg EU 811/2013

(3) Cooling: ambient air temperature 35°C, evaporator water temperature in/out 12/7 °C..

(4) Sound power level in accordance with ISO 3744..

(5) Sound pressure level at 10 mt from the unit in free field conditions in accordance with ISO 3744.



The refrigerant data may change without notice. It is therefore necessary to refer always to the silver label placed on the unit.

Reversible heating/cooling version (RV)

ACF/SLN/RV		22	30	40	45	50	60	70	75	90	105	115	140
Heating capacity (EN14511) ⁽¹⁾	kW	23,1	29,8	36,8	46,2	49,4	60,1	65,9	71,0	91,6	101,7	111,1	134,8
Total input power (EN14511) ⁽¹⁾	kW	5,6	7,2	8,8	11,2	11,7	13,4	15,1	16,7	20,9	23,9	27,0	30,5
COP (EN14511) ⁽¹⁾	W/W	4,12	4,13	4,20	4,12	4,21	4,50	4,35	4,25	4,39	4,26	4,11	4,42
Energy Class ⁽²⁾		A+	A+	A+	A+	A+	A++	A++	A++	A++	A++	A+	A++
SCOP ⁽²⁾	kWh/kWh	3,36	3,58	3,68	3,65	3,77	4,04	3,96	3,89	3,88	3,87	3,72	3,95
$\eta_{s,h}$ ⁽²⁾	%	131,2	140,2	144,0	143,0	147,9	158,6	155,4	152,7	152,2	151,6	145,7	155,1
Cooling capacity (EN14511) ⁽³⁾	kW	19,5	24,7	29,7	38,9	42,8	50,4	55,7	60,3	78,1	86,4	94,1	114,3
Total input power (EN14511) ⁽³⁾	kW	7,2	9,7	11,2	15,4	16,7	19,1	22,0	25,1	26,7	31,5	36,8	39,0
EER (EN14511) ⁽³⁾	W/W	2,72	2,55	2,65	2,54	2,57	2,64	2,53	2,40	2,93	2,74	2,56	2,93
Sound power level ⁽⁴⁾	dB (A)	70	70	70	70	72	72	72	73	75	76	78	80
Sound pressure level ⁽⁵⁾	dB (A)	38	38	38	38	40	40	40	41	43	44	46	48
SLN/RV		22	30	40	45	50	60	70	75	90	105	115	140
Heating capacity (EN14511) ⁽¹⁾	kW	23,1	29,8	36,9	46,3	49,7	60,0	65,9	71,0	91,4	101,4	111,0	134,5
Total input power (EN14511) ⁽¹⁾	kW	5,5	7,1	8,5	11,1	11,4	13,1	14,9	16,6	20,3	23,4	26,4	29,6
COP (EN14511) ⁽¹⁾	W/W	4,23	4,18	4,34	4,16	4,35	4,59	4,42	4,29	4,51	4,34	4,21	4,55
Energy Class ⁽²⁾		A++	A++	A++	A++	A++	A++	A++	A++	A++	A++	A++	A++
SCOP ⁽²⁾	kWh/kWh	3,83	3,86	3,92	3,91	3,98	4,19	4,09	4,00	4,05	4,01	3,86	4,13
$\eta_{s,h}$ ⁽²⁾	%	150,2	151,3	153,8	153,2	156,2	164,5	160,6	156,9	158,8	157,4	151,5	162,3
Cooling capacity (EN14511) ⁽³⁾	kW	19,7	25,4	30,4	39,9	44,1	52,4	57,5	63,4	80,5	90,2	100,5	117,4
Total input power (EN14511) ⁽³⁾	kW	7,0	9,3	10,9	14,9	16,2	18,3	21,3	24,0	26,6	31,2	35,2	38,6
EER (EN14511) ⁽³⁾	W/W	2,83	2,73	2,78	2,67	2,72	2,87	2,70	2,65	3,03	2,89	2,86	3,04
Sound power level ⁽⁴⁾	dB (A)	64	65	67	69	72	72	72	73	74	76	78	79
Sound pressure level ⁽⁵⁾	dB (A)	32	33	35	37	40	40	40	41	42	44	46	47
Power supply	V/Ph/Hz	400/3+N/50	400/3+N/50	400/3/50	400/3/50	400/3/50	400/3/50	400/3/50	400/3/50	400/3/50	400/3/50	400/3/50	400/3/50
Compressors / Circuits	n° / n°	2 / 1	2 / 1	2 / 1	2 / 1	2 / 1	2 / 1	2 / 1	2 / 1	2 / 1	2 / 1	2 / 1	2 / 1
Fans	n°	2	2	2	2	2	2	2	2	2	2	2	3
Refrigerant		R410A	R410A	R410A	R410A	R410A	R410A	R410A	R410A	R410A	R410A	R410A	R410A
Refrigerant charge	Kg	7,7	7,7	10,6	10,9	11,1	14,8	14,9	15,2	22,5	22,5	22,5	34,4
Global warming potential (GWP)		2088	2088	2088	2088	2088	2088	2088	2088	2088	2088	2088	2088
Equivalent CO ₂ charge	t	16,1	16,1	22,1	22,7	23,2	30,9	31,1	31,7	47,0	47,0	47,0	71,8

ACF/SLN/RV		150	170	180	210	240	230	270	300	340	365	410	465
Heating capacity (EN14511) ⁽¹⁾	kW	148,2	162,5	176,9	204,1	232,2	221,2	265,0	287,3	317,0	349,0	389,3	439,8
Total input power (EN14511) ⁽¹⁾	kW	33,8	39,3	43,9	48,1	53,8	54,0	62,6	69,7	78,3	85,5	97,8	109,1
COP (EN14511) ⁽¹⁾	W/W	4,39	4,13	4,03	4,24	4,32	4,10	4,23	4,12	4,05	4,08	3,98	4,03
Energy Class ⁽²⁾		A++	A++	A+	A++	A++	A+	A+	A+	A+	A++	A++	A+
SCOP ⁽²⁾	kWh/kWh	3,92	3,86	3,76	4,00	3,98	3,74	3,79	3,78	3,82	3,88	3,83	3,81
$\eta_{s,h}$ ⁽²⁾	%	153,7	151,3	147,3	156,8	156,3	146,5	148,6	148,2	149,8	152,0	150,3	149,2
Cooling capacity (EN14511) ⁽³⁾	kW	124,4	139,3	152,2	174,1	187,4	190,3	223,6	245,3	275,7	306,0	353,1	381,9
Total input power (EN14511) ⁽³⁾	kW	44,4	52,0	59,7	67,0	78,1	73,8	80,1	91,5	106,4	120,5	135,8	155,9
EER (EN14511) ⁽³⁾	W/W	2,80	2,68	2,55	2,60	2,40	2,58	2,79	2,68	2,59	2,54	2,60	2,45
Sound power level ⁽⁴⁾	dB (A)	81	81	81	83	84	81	83	84	84	84	86	87
Sound pressure level ⁽⁵⁾	dB (A)	49	49	49	51	52	49	51	52	52	52	54	55
SLN/RV		150	170	180	210	240	230	270	300	340	365	410	465
Heating capacity (EN14511) ⁽¹⁾	kW	147,7	162,2	175,5	202,8	230,8	220,5	264,9	287,2	317,0	348,5	407,2	441,7
Total input power (EN14511) ⁽¹⁾	kW	33,0	38,6	43,4	47,6	52,9	53,0	60,9	68,2	77,1	84,6	97,2	108,0
COP (EN14511) ⁽¹⁾	W/W	4,48	4,20	4,04	4,26	4,36	4,16	4,35	4,21	4,11	4,12	4,19	4,09
Energy Class ⁽²⁾		A++	A++	A++	A++	A++	A++	A++	A++	A++	A++	A++	A++
SCOP ⁽²⁾	kWh/kWh	4,06	4,01	3,85	4,10	4,06	3,84	3,97	3,92	3,96	3,97	3,97	3,91
$\eta_{s,h}$ ⁽²⁾	%	159,5	157,4	151,1	161,0	159,3	150,4	155,9	153,8	155,5	155,9	155,8	153,5
Cooling capacity (EN14511) ⁽³⁾	kW	129,5	146,8	159,2	180,4	202,1	198,5	231,0	259,7	289,4	322,6	368,5	406,9
Total input power (EN14511) ⁽³⁾	kW	44,1	50,8	58,8	66,2	73,3	72,7	80,5	89,2	105,2	118,2	135,0	151,3
EER (EN14511) ⁽³⁾	W/W	2,94	2,89	2,71	2,73	2,76	2,73	2,87	2,91	2,75	2,73	2,73	2,69
Sound power level ⁽⁴⁾	dB (A)	80	81	81	83	84	81	82	83	84	84	86	87
Sound pressure level ⁽⁵⁾	dB (A)	48	49	49	51	52	49	50	51	52	52	54	55
Power supply	V/Ph/Hz	400/3/50	400/3/50	400/3/50	400/3/50	400/3/50	400/3/50	400/3/50	400/3/50	400/3/50	400/3/50	400/3/50	400/3/50
Compressors / Circuits	n° / n°	2 / 1	2 / 1	2 / 1	2 / 1	2 / 1	4 / 2	4 / 2	4 / 2	4 / 2	4 / 2	4 / 2	4 / 2
Fans	n°	3	3	3	3	3	4	6	6	6	6	8	8
Refrigerant		R410A	R410A	R410A	R410A	R410A	R410A	R410A	R410A	R410A	R410A	R410A	R410A
Refrigerant charge	Kg	34,8	35,3	35,3	49,4	57,3	56,7	66,5	67,1	68,0	79,9	81,1	97,7
Global warming potential (GWP)		2088	2088	2088	2088	2088	2088	2088	2088	2088	2088	2088	2088
Equivalent CO ₂ charge	t	72,7	73,7	73,7	103,1	119,6	118,4	138,9	140,1	142,0	166,8	169,3	204,0

Performances are referred to the following conditions:

(1) Heating: Ambient temperature 7°C DB, 6°C WB, water temperature 30/35°C.

(2) Average conditions, low temperature, variable - Reg EU 811/2013

(3) Cooling: ambient air temperature 35°C, evaporator water temperature in/out 12/7 °C..

(4) Sound power level in accordance with ISO 3744..

(5) Sound pressure level at 10 mt from the unit in free field conditions in accordance with ISO 3744.



The refrigerant data may change without notice. It is therefore necessary to refer always to the silver label placed on the unit.

3.5 Operation limits

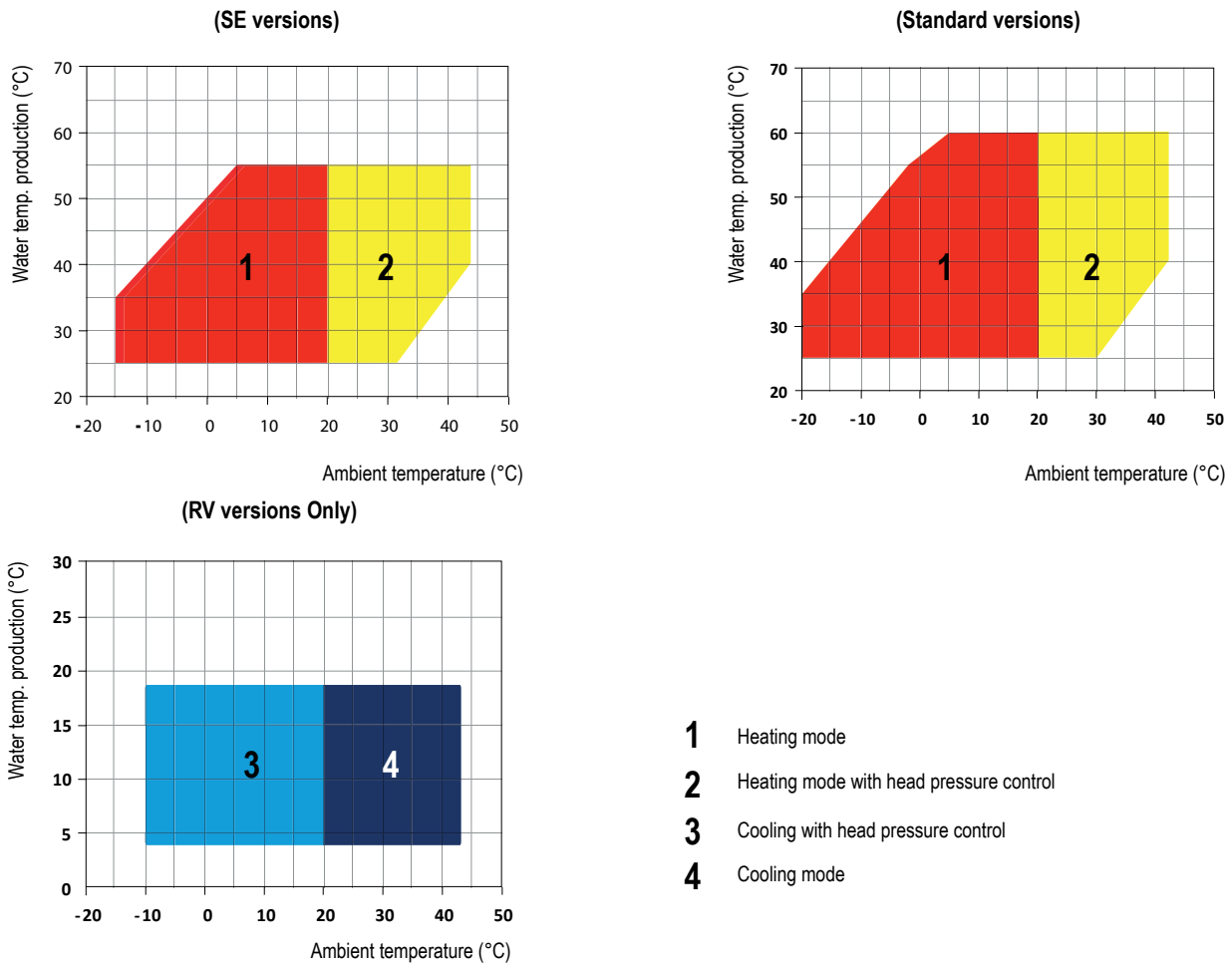

3.6.1 User heat exchanger water flow rate

The nominal water flow rate given is referred to a Δt of 5 °C. Maximum flow rate allowed is the one that presents a Δt of 3°C: higher values may cause too high pressure drop.

The minimum water flow rate allowed is the one presenting a Δt of 8°C.

Insufficient values cause too low evaporating temperatures with the action of safety devices which would stop the unit.

3.6.2 User hot water temperature (Winter operation)

Once the system is on temperature, the minimum user water temperature should not be less than 30°C.

Lower values could cause incorrect working operation of the compressor and compressor failure may occur.

The maximum user outlet water temperature cannot exceed 55°C for SE versions and 60°C for standard versions. Higher values may call the action of safety devices which would stop the unit.

3.6.3 Cold water temperature (RV versions Only)

The minimum user outlet water temperature allowed is 4°C.

To operates below this limit the unit should need some structural modifications. In this case please contact our company. The maximum user outlet water temperature 18°C.

3.6.4 Ambient air temperature

The units are designed and manufactured to operate, In winter operation (heating mode) from -20°C to 43°C.

In cooling mode the units can operate with ambient air temperatures from -10 to 43°C.



If the unit is installed in particularly windy areas, it will be necessary to provide some windbreaker barriers to avoid any malfunction. We suggest to install the barriers only if the wind exceeds 2,5m/s.



The units, in their standard configuration, are not suitable for installation in saline environments.



In WINTER mode, the unit can be started with external air of -20°C and cold inlet water (about 20°C). Such a configuration is allowed only for a short time and only to bring the plant to the right temperature. To reduce this setting time, we suggest to install a 3-way valve which allows to by-pass water from the user to the plant till the standard conditions are reached.



Units are designed and manufactured to European safety and technical standards. The units have been designed exclusively for heating, cooling and domestic hot water production (D.H.W.). The units must be used for this specific purpose only. The Company will not be liable for claims for damage caused to persons, animals or material goods or property caused by improper installation, adjustment and maintenance or improper use. Any use not specified in this manual is prohibited.



If it's required heating operation at outdoor temperatures above 20°C or cooling operation at outdoor temperatures below 20°C , is required an evaporating/condensing pressure control. The device monitors the evaporating/condensing pressure and maintains it at a constant level by modulating the airflow. It can also be used to reduce noise emission when ambient temperatures are lower (eg. at night). This accessory is supply as standard whit SE and HE versions.



In case of operations outside of these values, please contact the company.

3.6 Domestic hot water production

The production of domestic hot water through heat pump is a sensitive issue that deserves proper consideration. There are several systems of domestic hot water production by using heat pumps, each of which brings advantages and disadvantages. It is not subject of this manual to deal with the matter in depth and in the case, please contact the company for all the appropriate solutions.

In general, we can say that there are two main solutions, in the market, concerning the domestic hot water production:

3.6.1 Solution 1

This is the standard solution for new buildings where space and general plant layout can be designed for the specific application.

It consists in the production of the domestic hot water “instantaneously”, by using a instant heat exchanger (heat station), combined to a “technical water” accumulator at constant temperature. In such way we can obtain 3 main advantages:

- Domestic hot water quality . Because you are not storing the domestic hot water in a tank, it is not necessary to heat the water to higher temperatures to bacteriologically disinfect. The legionella bacteria is present only in still water.
- Energy efficient the “technical water” present in the tank, is stored at a temperature just few degrees higher than the required domestic hot water temperature and it is not necessary to increase the temperature of the tank at 63-65°C (temperature at which the legionella bacteria is killed). In this way it can be also possible to avoid the use of integration electric heaters or to keep them just in case of heat pump malfunctions or in very severe ambient conditions.
- Reduction of the fouling phenomena resulting in increased operational life of the plant.

In this case, the domestic hot water heat exchanger must be connected to a storage tank in a closed circuit. Please contact the company for the correct sizing. To connect the DHW domestic hot water cylinder it is required to install all the components mentioned in the above picture. The cylinder is fitted with a heat exchanger (copper coil or plate heat exchanger, depending on the version). The heat pump has to be connected to the volume of the storage cylinder. This is required to guarantee the correct operation of the unit, avoiding frequent start and stops of the compressors. The DHW water inlet and outlet are connected to the heat exchanger. This ensures direct heat exchange between the “technical” water stored in the cylinder and the flowing domestic hot water inside the heat exchanger. It is recommendable to control the temperature of the supplied domestic hot water by a thermostatic valve.

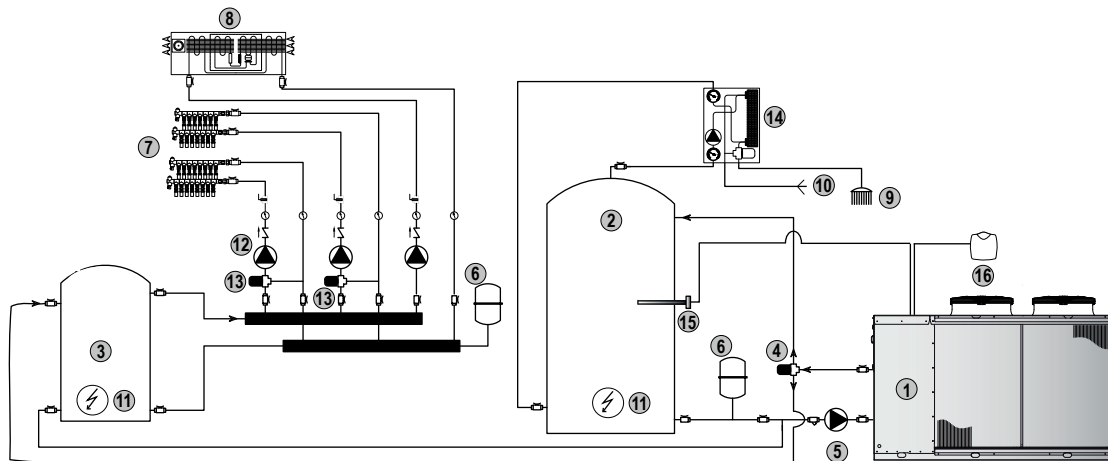

1	Heat pump	2	DHW Domestic hot water cylinder
3	Buffer storage tank	4	3 way ON/OFF valve Heating/DHW production
5	Primary circuit user water pump	6	Expansion vessel
7	Underfloor heating system	8	Dehumidifier / Cooling
9	Domestic hot water supply	10	Domestic cold water
11	Integration electric heater	12	Secondary circuit user water pumps
13	Underfloor heating modulating valves	14	Instantaneous domestic hot water producer
15	Domestic hot water sensor	16	Weather compensation sensor

3.6.2 Solution 2

This is the solution for existing buildings or for those applications where it is not possible to remove existing plants.

It consists in the accumulation of the domestic hot water inside the existing DHW water tank (that possibly is not designed properly for the combination with the new heat pump), by using the heat exchanger already present in the DHW tank.

In such way we can not obtain many advantages, just the **possibility of using the existing DHW tank**.

This system can be considered a compromise between costs and efficiency and need to be set correctly in order to have enough domestic hot water at the tap. The main risk of such systems is the incorrect sizing of the heat exchanger inside the DHW tank, who implies the frequent start and stop of the heat pump and possible frequent high pressure alarms. This happens due to the fact that the heat pump dissipates a much higher thermal capacity than the maximum possible allowed by the DHW heat exchanger. The result is a heat pump is frequently in stand-by operation, possible frequent high pressure alarms, and **COLD WATER in the tank**.

To help the heat pump in this solution, it is necessary to install a 3 way modulating valve (8) as shown in the below drawing. The valve, depending on the water temperature measured by the return sensor installed, standard, in the units, modulates the opening of the by-pass port, going to the user system, in order to use, **AS MUCH AS POSSIBLE**, the capacity of the existing heat exchanger. The 3 way valve (8) can be managed by the unit microprocessor.



This solution is only available in the two pipe systems. It can not be applied to units in 4 pipe systems version.

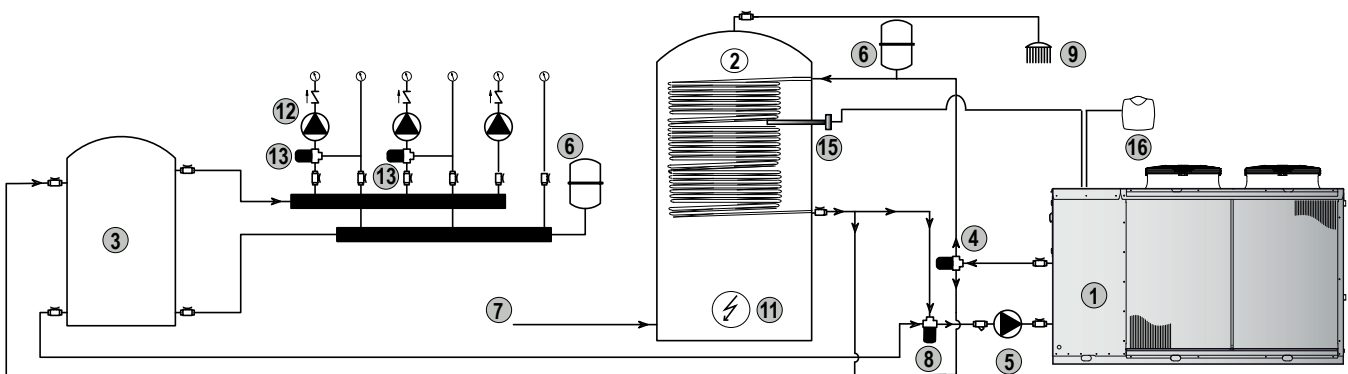

1	Heat pump	2	DHW Domestic hot water cylinder
3	Buffer storage tank	4	3 way ON/OFF valve Heating/DHW production
5	Primary circuit user water pump	6	Expansion vessel
7	Domestic cold water	8	3 way mixing valve
9	Domestic hot water supply	11	Integration electric heater
12	Secondary circuit user water pumps	13	Underfloor heating modulating valves
15	Domestic hot water sensor	16	Weather compensation sensor



The 3 way valve **MUST** have a maximum opening time period of 35 seconds. Longer opening time periods can create malfunctioning of the system with possible high pressure alarm in the heat pump.

3.7 Compressor capacity steps

Modello	NUMBER OF COMPRESSORS			
	1	2	3	4
22	50%	50%
30	50%	50%
40	50%	50%
45	50%	50%
50	50%	50%
60	50%	50%
70	50%	50%
75	50%	50%
90	50%	50%
105	43%	57%
115	50%	50%
140	45%	55%
150	50%	50%
170	45%	55%
180	50%	50%
210	43%	57%
240	50%	50%
230	25%	25%	25%	25%
270	22%	28%	22%	28%
300	25%	25%	25%	25%
340	22%	28%	22%	28%
365	25%	25%	25%	25%
410	22%	28%	22%	28%
465	25%	25%	25%	25%

3.8 Correction tables

3.8.1 Operation with glycol

Glycol percentage	Freezing point (°C)	CCF	IPCF	WFCF	PDCF
10	-3.2	0.985	1	1.02	1.08
20	-7.8	0.98	0.99	1.05	1.12
30	-14.1	0.97	0.98	1.09	1.22
40	-22.3	0.965	0.97	1.14	1.25
50	-33.8	0.955	0.965	1.2	1.33

CCF: Capacity correction factor

IPCF: Input power correction factor

WFCF: Water flow correction factor

PDCF: Pressure drops correction factor

The water flow rate and pressure drop correction factors are to be applied directly to the values given for operation without glycol. The water flow rate correction factor is calculated in order to maintain the same temperature difference as that which would be obtained without glycol. The pressure drop correction factor takes into account the different flow rate obtained from the application of the flow rate correction factor.

3.8.2 Correction tables different Δt

Water temperature diff.(°C)	3	5	8
CCCP	0.99	1	1.02
IPCF	0.99	1	1.01

CCCP = Cooling capacity correction factor

IPCF = Input power correction factor

3.8.3 Correction tables different Fouling factors

Fouling factor	0.00005	0.0001	0.0002
CCCP	1	0.98	0.94
IPCF	1	0.98	0.95

CCCP = Cooling capacity correction factor

IPCF = Input power correction factor

3.9 Sound data

SE / ACF											
Mod.	Octave bands (Hz)								Lw		Lp
	63 dB	125 dB	250 dB	500 dB	1K dB	2K dB	4K dB	8K dB	dB	dB(A)	dB(A)
22	88,1	79,3	73,2	71,7	70,6	65,2	61,8	52,7	88,9	75	43
30	88,1	79,3	73,2	71,7	70,6	65,2	61,8	52,7	88,9	75	43
40	88,1	79,3	73,2	71,7	70,6	65,2	61,8	52,7	88,9	75	43
45	88,1	79,3	73,2	71,7	70,6	65,2	61,8	52,7	88,9	75	43
50	90,1	81,3	75,2	73,7	72,6	67,2	63,8	54,7	90,9	77	45
60	90,1	81,3	75,2	73,7	72,6	67,2	63,8	54,7	90,9	77	45
70	90,1	81,3	75,2	73,7	72,6	67,2	63,8	54,7	90,9	77	45
75	91,1	82,3	76,2	74,7	73,6	68,2	64,8	55,7	91,9	78	46
90	92,1	83,3	77,2	75,7	74,6	69,2	65,8	56,7	92,9	79	47
105	95,1	86,3	80,2	78,7	77,6	72,2	68,8	59,7	95,9	82	50
115	96,1	87,3	81,2	79,7	78,6	73,2	69,8	60,7	96,9	83	51
140	98,1	89,3	83,2	81,7	80,6	75,2	71,8	62,7	98,9	85	53
150	99,1	90,3	84,2	82,7	81,6	76,2	72,8	63,7	99,9	86	54
170	99,1	90,3	84,2	82,7	81,6	76,2	72,8	63,7	99,9	86	54
180	99,1	90,3	84,2	82,7	81,6	76,2	72,8	63,7	99,9	86	54
210	102,1	93,3	87,2	85,7	84,6	79,2	75,8	66,7	102,9	89	57
240	103,1	94,3	88,2	86,7	85,6	80,2	76,8	67,7	103,9	90	58
230	100,1	91,3	85,2	83,7	82,6	77,2	73,8	64,7	100,9	87	55
270	102,1	93,3	87,2	85,7	84,6	79,2	75,8	66,7	102,9	89	57
300	103,1	94,3	88,2	86,7	85,6	80,2	76,8	67,7	103,9	90	58
340	103,1	94,3	88,2	86,7	85,6	80,2	76,8	67,7	103,9	90	58
365	103,1	94,3	88,2	86,7	85,6	80,2	76,8	67,7	103,9	90	58
410	105,1	96,3	90,2	88,7	87,6	82,2	78,8	69,7	105,9	92	60
465	106,1	97,3	91,2	89,7	88,6	83,2	79,8	70,7	106,9	93	61
SE											
22	87,1	78,3	72,2	70,7	69,6	64,2	60,8	51,7	87,9	74	42
30	87,1	78,3	72,2	70,7	69,6	64,2	60,8	51,7	87,9	74	42
40	88,1	79,3	73,2	71,7	70,6	65,2	61,8	52,7	88,9	75	43
45	88,1	79,3	73,2	71,7	70,6	65,2	61,8	52,7	88,9	75	43
50	90,1	81,3	75,2	73,7	72,6	67,2	63,8	54,7	90,9	77	45
60	90,1	81,3	75,2	73,7	72,6	67,2	63,8	54,7	90,9	77	45
70	90,1	81,3	75,2	73,7	72,6	67,2	63,8	54,7	90,9	77	45
75	91,1	82,3	76,2	74,7	73,6	68,2	64,8	55,7	91,9	78	46
90	92,1	83,3	77,2	75,7	74,6	69,2	65,8	56,7	92,9	79	47
105	95,1	86,3	80,2	78,7	77,6	72,2	68,8	59,7	95,9	82	50
115	96,1	87,3	81,2	79,7	78,6	73,2	69,8	60,7	96,9	83	51
140	98,1	89,3	83,2	81,7	80,6	75,2	71,8	62,7	98,9	85	53
150	99,1	90,3	84,2	82,7	81,6	76,2	72,8	63,7	99,9	86	54
170	99,1	90,3	84,2	82,7	81,6	76,2	72,8	63,7	99,9	86	54
180	99,1	90,3	84,2	82,7	81,6	76,2	72,8	63,7	99,9	86	54
210	102,1	93,3	87,2	85,7	84,6	79,2	75,8	66,7	102,9	89	57
240	103,1	94,3	88,2	86,7	85,6	80,2	76,8	67,7	103,9	90	58
230	100,1	91,3	85,2	83,7	82,6	77,2	73,8	64,7	100,9	87	55
270	102,1	93,3	87,2	85,7	84,6	79,2	75,8	66,7	102,9	89	57
300	103,1	94,3	88,2	86,7	85,6	80,2	76,8	67,7	103,9	90	58
340	103,1	94,3	88,2	86,7	85,6	80,2	76,8	67,7	103,9	90	58
365	103,1	94,3	88,2	86,7	85,6	80,2	76,8	67,7	103,9	90	58
410	105,1	96,3	90,2	88,7	87,6	82,2	78,8	69,7	105,9	92	60
465	106,1	97,3	91,2	89,7	88,6	83,2	79,8	70,7	106,9	93	61

Lw: Sound power level according to ISO 3744.

Lp: Sound pressure level measured at 10 mt from the unit in free field conditions direction factor Q=2 according to ISO 3744.

ACF											
Mod.	Octave bands (Hz)								Lw		Lp
	63 dB	125 dB	250 dB	500 dB	1K dB	2K dB	4K dB	8K dB	dB	dB(A)	dB(A)
22	88,1	79,3	73,2	71,7	70,6	65,2	61,8	52,7	88,9	75	43
30	88,1	79,3	73,2	71,7	70,6	65,2	61,8	52,7	88,9	75	43
40	88,1	79,3	73,2	71,7	70,6	65,2	61,8	52,7	88,9	75	43
45	88,1	79,3	73,2	71,7	70,6	65,2	61,8	52,7	88,9	75	43
50	89,1	80,3	74,2	72,7	71,6	66,2	62,8	53,7	89,9	76	44
60	89,1	80,3	74,2	72,7	71,6	66,2	62,8	53,7	89,9	76	44
70	90,1	81,3	75,2	73,7	72,6	67,2	63,8	54,7	90,9	77	45
75	91,1	82,3	76,2	74,7	73,6	68,2	64,8	55,7	91,9	78	46
90	95,1	86,3	80,2	78,7	77,6	72,2	68,8	59,7	95,9	82	50
105	96,1	87,3	81,2	79,7	78,6	73,2	69,8	60,7	96,9	83	51
115	98,1	89,3	83,2	81,7	80,6	75,2	71,8	62,7	98,9	85	53
140	99,1	90,3	84,2	82,7	81,6	76,2	72,8	63,7	99,9	86	54
150	100,1	91,3	85,2	83,7	82,6	77,2	73,8	64,7	100,9	87	55
170	100,1	91,3	85,2	83,7	82,6	77,2	73,8	64,7	100,9	87	55
180	100,1	91,3	85,2	83,7	82,6	77,2	73,8	64,7	100,9	87	55
210	102,1	93,3	87,2	85,7	84,6	79,2	75,8	66,7	102,9	89	57
240	104,1	95,3	89,2	87,7	86,6	81,2	77,8	68,7	104,9	91	59
230	101,1	92,3	86,2	84,7	83,6	78,2	74,8	65,7	101,9	88	56
270	102,1	93,3	87,2	85,7	84,6	79,2	75,8	66,7	102,9	89	57
300	103,1	94,3	88,2	86,7	85,6	80,2	76,8	67,7	103,9	90	58
340	103,1	94,3	88,2	86,7	85,6	80,2	76,8	67,7	103,9	90	58
365	103,1	94,3	88,2	86,7	85,6	80,2	76,8	67,7	103,9	90	58
410	105,1	96,3	90,2	88,7	87,6	82,2	78,8	69,7	105,9	92	60
465	105,1	96,3	90,2	88,7	87,6	82,2	78,8	69,7	105,9	92	60
STANDARD											
22	86,1	77,3	71,2	69,7	68,6	63,2	59,8	50,7	86,9	73	41
30	87,1	78,3	72,2	70,7	69,6	64,2	60,8	51,7	87,9	74	42
40	87,1	78,3	72,2	70,7	69,6	64,2	60,8	51,7	87,9	74	42
45	88,1	79,3	73,2	71,7	70,6	65,2	61,8	52,7	88,9	75	43
50	89,1	80,3	74,2	72,7	71,6	66,2	62,8	53,7	89,9	76	44
60	89,1	80,3	74,2	72,7	71,6	66,2	62,8	53,7	89,9	76	44
70	90,1	81,3	75,2	73,7	72,6	67,2	63,8	54,7	90,9	77	45
75	91,1	82,3	76,2	74,7	73,6	68,2	64,8	55,7	91,9	78	46
90	95,1	86,3	80,2	78,7	77,6	72,2	68,8	59,7	95,9	82	50
105	96,1	87,3	81,2	79,7	78,6	73,2	69,8	60,7	96,9	83	51
115	98,1	89,3	83,2	81,7	80,6	75,2	71,8	62,7	98,9	85	53
140	99,1	90,3	84,2	82,7	81,6	76,2	72,8	63,7	99,9	86	54
150	100,1	91,3	85,2	83,7	82,6	77,2	73,8	64,7	100,9	87	55
170	100,1	91,3	85,2	83,7	82,6	77,2	73,8	64,7	100,9	87	55
180	100,1	91,3	85,2	83,7	82,6	77,2	73,8	64,7	100,9	87	55
210	102,1	93,3	87,2	85,7	84,6	79,2	75,8	66,7	102,9	89	57
240	104,1	95,3	89,2	87,7	86,6	81,2	77,8	68,7	104,9	91	59
230	101,1	92,3	86,2	84,7	83,6	78,2	74,8	65,7	101,9	88	56
270	102,1	93,3	87,2	85,7	84,6	79,2	75,8	66,7	102,9	89	57
300	103,1	94,3	88,2	86,7	85,6	80,2	76,8	67,7	103,9	90	58
340	103,1	94,3	88,2	86,7	85,6	80,2	76,8	67,7	103,9	90	58
365	103,1	94,3	88,2	86,7	85,6	80,2	76,8	67,7	103,9	90	58
410	105,1	96,3	90,2	88,7	87,6	82,2	78,8	69,7	105,9	92	60
465	105,1	96,3	90,2	88,7	87,6	82,2	78,8	69,7	105,9	92	60

Lw: Sound power level according to ISO 3744.

Lp: Sound pressure level measured at 10 mt from the unit in free field conditions direction factor Q=2 according to ISO 3744.

ACF / SLN											
Mod.	Octave bands (Hz)								Lw		Lp
	63	125	250	500	1K	2K	4K	8K	dB	dB(A)	dB(A)
	dB	dB	dB	dB	dB	dB	dB	dB			
22	83,1	74,3	68,2	66,7	65,6	60,2	56,8	47,7	83,9	70	38
30	83,1	74,3	68,2	66,7	65,6	60,2	56,8	47,7	83,9	70	38
40	83,1	74,3	68,2	66,7	65,6	60,2	56,8	47,7	83,9	70	38
45	83,1	74,3	68,2	66,7	65,6	60,2	56,8	47,7	83,9	70	38
50	85,1	76,3	70,2	68,7	67,6	62,2	58,8	49,7	85,9	72	40
60	85,1	76,3	70,2	68,7	67,6	62,2	58,8	49,7	85,9	72	40
70	85,1	76,3	70,2	68,7	67,6	62,2	58,8	49,7	85,9	72	40
75	86,1	77,3	71,2	69,7	68,6	63,2	59,8	50,7	86,9	73	41
90	88,1	79,3	73,2	71,7	70,6	65,2	61,8	52,7	88,9	75	43
105	89,1	80,3	74,2	72,7	71,6	66,2	62,8	53,7	89,9	76	44
115	91,1	82,3	76,2	74,7	73,6	68,2	64,8	55,7	91,9	78	46
140	93,1	84,3	78,2	76,7	75,6	70,2	66,8	57,7	93,9	80	48
150	94,1	85,3	79,2	77,7	76,6	71,2	67,8	58,7	94,9	81	49
170	94,1	85,3	79,2	77,7	76,6	71,2	67,8	58,7	94,9	81	49
180	94,1	85,3	79,2	77,7	76,6	71,2	67,8	58,7	94,9	81	49
210	96,1	87,3	81,2	79,7	78,6	73,2	69,8	60,7	96,9	83	51
240	97,1	88,3	82,2	80,7	79,6	74,2	70,8	61,7	97,9	84	52
230	94,1	85,3	79,2	77,7	76,6	71,2	67,8	58,7	94,9	81	49
270	96,1	87,3	81,2	79,7	78,6	73,2	69,8	60,7	96,9	83	51
300	97,1	88,3	82,2	80,7	79,6	74,2	70,8	61,7	97,9	84	52
340	97,1	88,3	82,2	80,7	79,6	74,2	70,8	61,7	97,9	84	52
365	97,1	88,3	82,2	80,7	79,6	74,2	70,8	61,7	97,9	84	52
410	99,1	90,3	84,2	82,7	81,6	76,2	72,8	63,7	99,9	86	54
465	100,1	91,3	85,2	83,7	82,6	77,2	73,8	64,7	100,9	87	55

SLN											
Mod.	63	125	250	500	1K	2K	4K	8K	Lw	Lp	Lp
	dB	dB	dB	dB	dB	dB	dB	dB	dB	dB(A)	dB(A)
22	77,1	68,3	62,2	60,7	59,6	54,2	50,8	41,7	77,9	64	32
30	78,1	69,3	63,2	61,7	60,6	55,2	51,8	42,7	78,9	65	33
40	80,1	71,3	65,2	63,7	62,6	57,2	53,8	44,7	80,9	67	35
45	82,1	73,3	67,2	65,7	64,6	59,2	55,8	46,7	82,9	69	37
50	85,1	76,3	70,2	68,7	67,6	62,2	58,8	49,7	85,9	72	40
60	85,1	76,3	70,2	68,7	67,6	62,2	58,8	49,7	85,9	72	40
70	85,1	76,3	70,2	68,7	67,6	62,2	58,8	49,7	85,9	72	40
75	86,1	77,3	71,2	69,7	68,6	63,2	59,8	50,7	86,9	73	41
90	87,1	78,3	72,2	70,7	69,6	64,2	60,8	51,7	87,9	74	42
105	89,1	80,3	74,2	72,7	71,6	66,2	62,8	53,7	89,9	76	44
115	91,1	82,3	76,2	74,7	73,6	68,2	64,8	55,7	91,9	78	46
140	92,1	83,3	77,2	75,7	74,6	69,2	65,8	56,7	92,9	79	47
150	93,1	84,3	78,2	76,7	75,6	70,2	66,8	57,7	93,9	80	48
170	94,1	85,3	79,2	77,7	76,6	71,2	67,8	58,7	94,9	81	49
180	94,1	85,3	79,2	77,7	76,6	71,2	67,8	58,7	94,9	81	49
210	96,1	87,3	81,2	79,7	78,6	73,2	69,8	60,7	96,9	83	51
240	97,1	88,3	82,2	80,7	79,6	74,2	70,8	61,7	97,9	84	52
230	94,1	85,3	79,2	77,7	76,6	71,2	67,8	58,7	94,9	81	49
270	95,1	86,3	80,2	78,7	77,6	72,2	68,8	59,7	95,9	82	50
300	96,1	87,3	81,2	79,7	78,6	73,2	69,8	60,7	96,9	83	51
340	97,1	88,3	82,2	80,7	79,6	74,2	70,8	61,7	97,9	84	52
365	97,1	88,3	82,2	80,7	79,6	74,2	70,8	61,7	97,9	84	52
410	99,1	90,3	84,2	82,7	81,6	76,2	72,8	63,7	99,9	86	54
465	100,1	91,3	85,2	83,7	82,6	77,2	73,8	64,7	100,9	87	55

Lw: Sound power level according to ISO 3744.

Lp: Sound pressure level measured at 10 mt from the unit in free field conditions direction factor Q=2 according to ISO 3744.

4. INSTALLATION

4.1 General safety guidelines and use of symbols



Before undertaking any task the operator must be fully trained in the operation of the machines to be used and their controls. They must also have read and be fully conversant with all operating instructions.



All maintenance must be performed by TRAINED personnel and be in accordance with all national and local regulations.



The installation and maintenance of the unit must comply with the local regulations in force at the time of the installation.



Avoid contact and do not insert any objects into moving parts.

4.2 Health and safety Considerations



The workplace must be kept clean, tidy and free from objects that may prevent free movement. Appropriate lighting of the work place shall be provided to allow the operator to perform the required operations safely. Poor or too strong lighting can cause risks.



Ensure that work places are always adequately ventilated and that respirators are working, in good condition and comply fully with the requirements of the current regulations.

4.3 Personal protective equipment



When operating and maintaining the unit, use the following personal protective equipment listed below as required by law.



Protective footwear.



Eye protection.



Protective gloves.



Respiratory protection.



Hearing protection.

4.4 Inspection

When installing or servicing the unit, it is necessary to strictly follow the rules reported on this manual, to conform to all the specifications of the labels on the unit, and to take any possible precautions of the case. Not observing the rules reported on this manual can create dangerous situations. After receiving the unit, immediately check its integrity. The unit left the factory in perfect conditions; any eventual damage must be questioned to the carrier and recorded on the Delivery Note before it is signed. The company must be informed, within 8 days, of the extent of the damage. The Customer should prepare a written statement of any severe damage.

Before accepting the unit check:

- The unit did not suffer any damage during transport;
- The delivered goods are conforming to what shown in the delivery note.

In Case of Damage

- List the damage on the delivery note
- Inform the Company of the extent of the damage within 8 days of receipt of the goods. After this time any claim will not be considered.
- A full written report is required for cases of severe damage.

4.5 Storage

Units should be stored under cover and ideally, should remain in their packaging. The tools that are supplied for opening the electric box should be formally transferred to the person responsible for the plant.

4.5.1 Shipment

The shipment must be carried out by authorised carriers and the characteristics of the vehicle used must be such as to avoid damaging the machinery transported/to be transported, neither during loading and unloading nor during transport. If the roads to be driven are irregular, the vehicle must be fitted with special suspensions or internal walls in order not to damage the unit during the shipment.



The maximum ambient temperature for storage/shipment is +45°C and the minimum is -20°C,

4.6 Unpacking



Packaging could be dangerous for the operators.

It is advisable to leave packaged units during handling and remove it before the installation. The packaging must be removed carefully to prevent any possible damage to the machine. The materials constituting the packaging may be different in nature (wood, cardboard, nylon, etc.).



The packaging materials should be separated and sent for disposal or possible recycling to specialist waste companies.

4.7 Lifting and handling

When unloading the unit, it is strongly recommended that sudden movements are avoided in order to protect the refrigerant circuit, copper tubes or any other unit component. Units can be lifted by using a forklift or, alternatively, using belts. Take care that the method of lifting does not damage the side panels or the cover. It is important to keep the unit horizontal at all time to avoid damage to the internal components.



The Source heat exchangers fins are sharp. Use protection gloves.

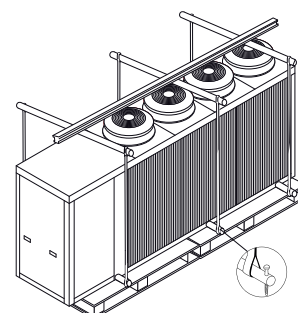

4.8 Location and minimum technical clearances

All units are designed for external installation : any overhang above the unit and location near trees, if they partially cover the unit, must be avoided in order to prevent air by-pass. It is advisable to create a proper mounting plinth, with a size similar to the unit foot-print. Unit vibration level is very low: it is advisable however, to install vibration dampers (spring or rubber) between the plinth and the unit base-frame to keep vibrations at a very low level. It is vital to ensure adequate air volume to the source fan. Re-circulation of discharge air must be avoided; failure to observe this point will result in poor performance or activation of safety controls. For these reasons it is necessary to observe the following clearances:



The unit has to be installed such that maintenance and repair is possible. The warranty does not cover costs for the provision of lifting apparatus, platforms or other lifting systems required to perform repairs during warranty period.



The installation site should be chosen in accordance with EN 378-1 and 378-3 standards. When choosing the installation site, all risks caused by accidental refrigerant leakage should be taken into consideration.



All air to water heat pumps, during defrost mode, produce condensate at the base of the source heat exchanger. If the ambient temperature is below 0°C the water may freeze, creating a thick layer of ice within the unit. This layer of ice, in specific conditions, may damage the heat exchanger and therefore, to guarantee correct operation of the units it is highly recommended to raise the unit of a minimum amount (H). This recommendation becomes more important if the unit is to be installed in a location that is subject to heavy snowfall.

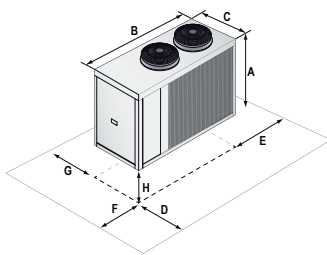

SE 22 - 30 - 40
STD/ACF 22 - 30

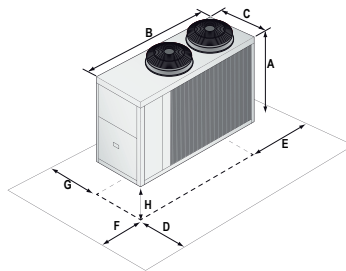

SE 45 - 50 - 60
STD/ACF 40 - 45 - 50 - 602

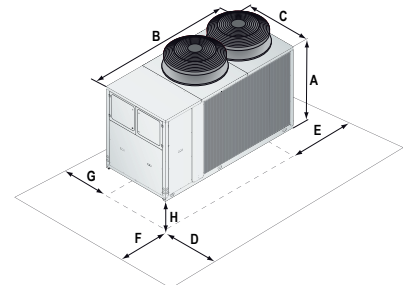

SE 70 - 75 - 90
STD/ACF 70 - 75 - 90 - 105 - 115

		22	30	40	45	50	60	70	75
A (mm)	SE	1500	1500	1500	1680	1680	1680	1880	1880
B (mm)	SE	1915	1915	1915	2115	2115	2115	2905	2905
C (mm)	SE	875	875	875	875	875	875	1145	1145
D (mm)	SE	1000	1000	1000	1500	1500	1500	2000	2000
E (mm)	SE	800	800	800	1000	1000	1000	1000	1000
F (mm)	SE	800	800	800	1000	1000	1000	1000	1000
G (mm)	SE	800	800	800	1000	1000	1000	1000	1000
H (mm)	SE	350	350	350	350	350	350	350	350
A (mm)	STD/ACF	1500	1500	1680	1680	1680	1880	1880	1880
B (mm)	STD/ACF	1915	1915	2115	2115	2115	2905	2905	2905
C (mm)	STD/ACF	875	875	875	875	875	1145	1145	1145
D (mm)	STD/ACF	1000	1000	1500	1500	1500	2000	2000	2000
E (mm)	STD/ACF	800	800	1000	1000	1000	1000	1000	1000
F (mm)	STD/ACF	800	800	1000	1000	1000	1000	1000	1000
G (mm)	STD/ACF	800	800	1000	1000	1000	1000	1000	1000
H (mm)	STD/ACF	350	350	350	350	350	350	350	350
A (mm)	SLN	1500	1500	1680	1680	1680	1880	1880	1880
B (mm)	SLN	1915	1915	2115	2115	2115	2905	2905	2905
C (mm)	SLN	875	875	875	875	875	1145	1145	1145
D (mm)	SLN	1000	1000	1500	1500	1500	2000	2000	2000
E (mm)	SLN	800	800	1000	1000	1000	1000	1000	1000
F (mm)	SLN	800	800	1000	1000	1000	1000	1000	1000
G (mm)	SLN	800	800	1000	1000	1000	1000	1000	1000
H (mm)	SLN	350	350	350	350	350	350	350	350



The unit has to be installed such that maintenance and repair is possible. The warranty does not cover costs for the provision of lifting apparatus, platforms or other lifting systems required to perform repairs during warranty period.



The installation site should be chosen in accordance with EN 378-1 and 378-3 standards. When choosing the installation site, all risks caused by accidental refrigerant leakage should be taken into consideration.



All air to water heat pumps, during defrost mode, produce condensate at the base of the source heat exchanger. If the ambient temperature is below 0°C the water may freeze, creating a thick layer of ice within the unit. This layer of ice, in specific conditions, may damage the heat exchanger and therefore, to guarantee correct operation of the units it is highly recommended to raise the unit of a minimum amount (H). This recommendation becomes more important if the unit is to be installed in a location that is subject to heavy snowfall.

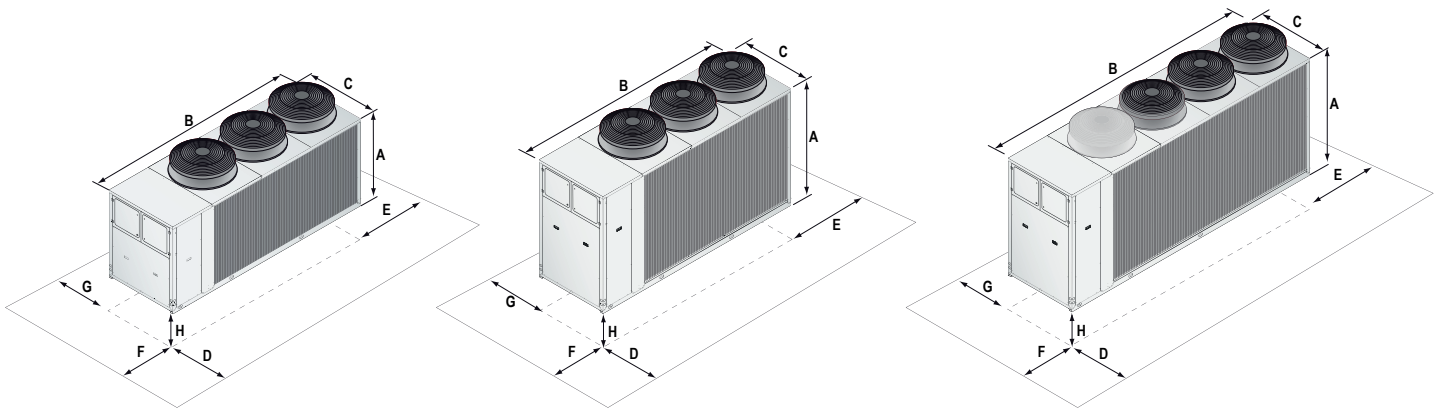

SE 105 - 115 - 140 - 150
STD/ACF 140 - 150 - 170 - 180

SE 170 - 180
STD/ACF 240 - 230

SE 240 - 230

		90	105	115	140	150	170	180	210
A (mm)	SE	1880	1880	1880	1880	1880	2270	2270	2310
B (mm)	SE	2905	3905	3905	3905	3905	3905	3905	4505
C (mm)	SE	1145	1145	1145	1145	1145	1145	1145	1145
D (mm)	SE	2000	2000	2000	2000	2000	2000	2000	2000
E (mm)	SE	1000	1000	1000	1000	1000	1000	1000	1000
F (mm)	SE	1000	1000	1000	1000	1000	1500	1500	1500
G (mm)	SE	1000	1000	1000	1000	1000	1000	1000	2000
H (mm)	SE	350	350	350	350	350	350	350	350
A (mm)	STD/ACF	1880	1880	1880	1880	1880	180	1880	2270
B (mm)	STD/ACF	2905	2905	2905	3905	3905	3905	3905	3905
C (mm)	STD/ACF	1145	1145	1145	1145	1145	1145	1145	1145
D (mm)	STD/ACF	2000	2000	2000	2000	2000	2000	2000	2000
E (mm)	STD/ACF	1000	1000	1000	1000	1000	1000	1000	1000
F (mm)	STD/ACF	1000	1000	1000	1000	1000	1500	1500	1500
G (mm)	STD/ACF	2000	2000	2000	2000	2000	2000	2000	2000
H (mm)	STD/ACF	350	350	350	350	350	350	350	350
A (mm)	SLN	1880	1880	1880	1880	1880	1880	1880	2270
B (mm)	SLN	2905	2905	2905	3905	3905	3905	3905	3905
C (mm)	SLN	1145	1145	1145	1145	1145	1145	1145	1145
D (mm)	SLN	2000	2000	2000	2000	2000	2000	2000	2000
E (mm)	SLN	1000	1000	1000	1000	1000	1000	1000	1000
F (mm)	SLN	1000	1000	1000	1000	1000	1500	1500	1500
G (mm)	SLN	2000	2000	2000	2000	2000	2000	2000	2000
H (mm)	SLN	350	350	350	350	350	350	350	350



The unit has to be installed such that maintenance and repair is possible. The warranty does not cover costs for the provision of lifting apparatus, platforms or other lifting systems required to perform repairs during warranty period.



The installation site should be chosen in accordance with EN 378-1 and 378-3 standards. When choosing the installation site, all risks caused by accidental refrigerant leakage should be taken into consideration.



All air to water heat pumps, during defrost mode, produce condensate at the base of the source heat exchanger. If the ambient temperature is below 0°C the water may freeze, creating a thick layer of ice within the unit. This layer of ice, in specific conditions, may damage the heat exchanger and therefore, to guarantee correct operation of the units it is highly recommended to raise the unit of a minimum amount (H). This recommendation becomes more important if the unit is to be installed in a location that is subject to heavy snowfall.

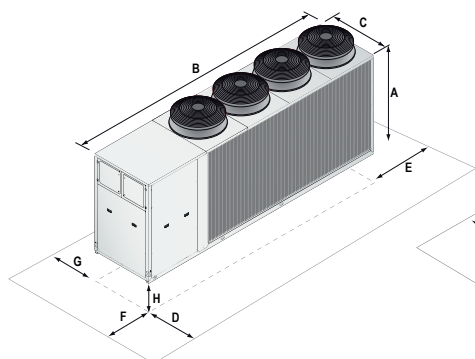

SE 230 - 270 - 300

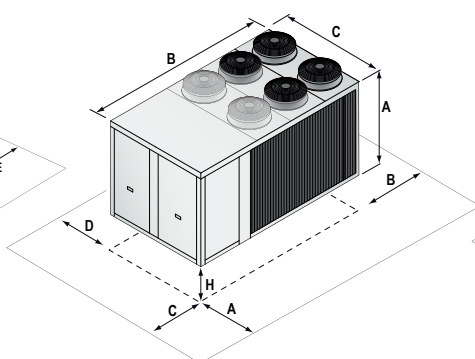

SE 340 - 365
STD/ACF 230 - 270 - 300 - 340

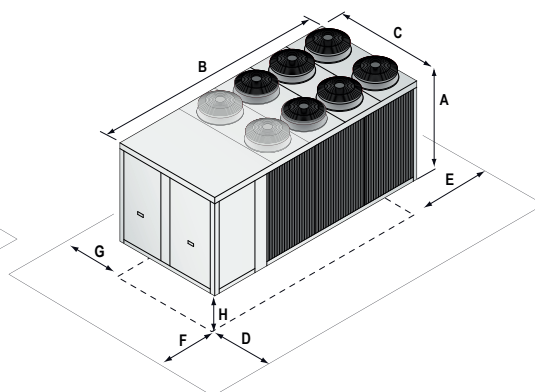

SE 410 - 465
STD/ACF 365 - 410 - 465

		240	230	270	300	340	365	410	465
A (mm)	SE	2310	2305	2305	2305	2355	2355	2370	2370
B (mm)	SE	4505	5295	5295	5295	4205	4205	4805	4805
C (mm)	SE	1145	1145	1145	1145	2190	2190	2190	2190
D (mm)	SE	2000	2000	2000	2000	2000	2000	2000	2000
E (mm)	SE	1000	1000	1000	1000	1000	1000	1000	1000
F (mm)	SE	1500	1500	1500	1500	1500	1500	1500	1500
G (mm)	SE	2000	2000	2000	2000	2000	2000	2000	2000
H (mm)	SE	350	350	350	350	350	350	350	350
A (mm)	STD/ACF	2270	2355	2355	2355	2355	2370	2370	2370
B (mm)	STD/ACF	3905	4205	4205	4205	4205	4805	4805	4805
C (mm)	STD/ACF	1145	2190	2190	2190	2190	2190	2190	2190
D (mm)	STD/ACF	2000	2000	2000	2000	2000	2000	2000	2000
E (mm)	STD/ACF	1000	1000	1000	1000	1000	1000	1000	1000
F (mm)	STD/ACF	1500	1500	1500	1500	1500	1500	1500	1500
G (mm)	STD/ACF	2000	2000	2000	2000	2000	2000	2000	2000
H (mm)	STD/ACF	350	350	350	350	350	350	350	350
A (mm)	SLN	2280	2355	2355	2355	2355	2350	2350	2350
B (mm)	SLN	3905	4205	4205	4205	4205	4805	4805	4805
C (mm)	SLN	1145	2210	2210	2210	2210	2210	2210	2210
D (mm)	SLN	2000	2000	2000	2000	2000	2000	2000	2000
E (mm)	SLN	1000	1000	1000	1000	1000	1000	1000	1000
F (mm)	SLN	1500	1500	1500	1500	1500	1500	1500	1500
G (mm)	SLN	2000	2000	2000	2000	2000	2000	2000	2000
H (mm)	SLN	350	350	350	350	350	350	350	350

4.9 Installation of rubber vibration dampers

All units should be installed on vibration dampers in order to prevent the transmission of vibration to the supporting surface and reduce the noise level. Rubber vibration dampers are available as an option in the catalogue. The vibration dampers (optional) are supplied by the factory in separate packaging.

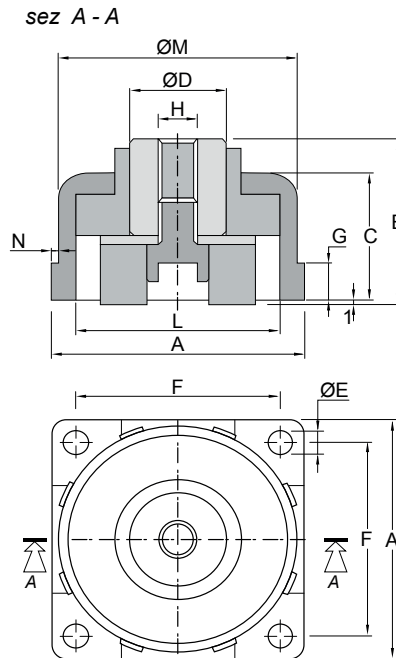

Mod.	A	B	C	D	E	F	G	H	L	M	N
22÷40	88 mm	52 mm	41 mm	25 mm	11 mm	67 mm	10 mm	M12	65 mm	74,5 mm	5,5 mm
45÷60	88 mm	52 mm	41 mm	25 mm	11 mm	67 mm	10 mm	M12	65 mm	74,5 mm	5,5 mm
70÷240	88 mm	52 mm	41 mm	25 mm	11 mm	67 mm	10 mm	M12	65 mm	74,5 mm	5,5 mm
230÷465	145 mm	79 mm	65 mm	35 mm	12,5 mm	110 mm	12 mm	M16	118 mm	129 mm	8 mm

4.10 Serial interface card RS485

Supervision system interface (MODBUS RS485 available only)

This system allows you to remotely monitor all parameters of the unit and change their values.

It is necessary to respect the polarity of the wiring as shown in the diagram. Any reversal of polarity will result in the non-functioning unit.

The supervision connectivity cable must be telephone one type 2x0, 25 mm².

The unit is configured at the factory with serial address 1. In case of using the MODBUS system, you can request the list of variables by contacting the assistance.

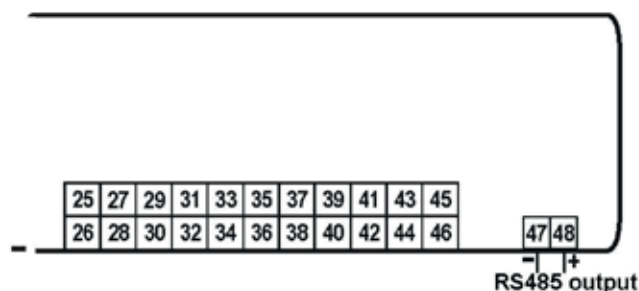

4.11 Installation of condensate drip tray



In heating and domestic hot water mode, the unit can produce a quantity of condensate, depending upon the ambient conditions and the working hours. This condensate may freeze in severe ambient conditions. The unit must therefore be installed in such a way as to prevent a slipping hazard to the user or third parties due to the presence of ice around the heat pump.



Installing the condensate drip tray on site may be difficult. We recommend that you request the BRCA accessory when ordering the unit so that it can be installed at the factory.

In all the units can be installed a drip tray that, positioned underneath the source heat exchanger (finned coil) and above the base frame, recovers all water generated by the unit when in heating and domestic hot water working mode. The drip tray is supplied with a self-heating antifreeze kit that melts the any ice present in the drip tray. The drip tray is supplied with a discharge connection that must be connected to a discharge pipe.

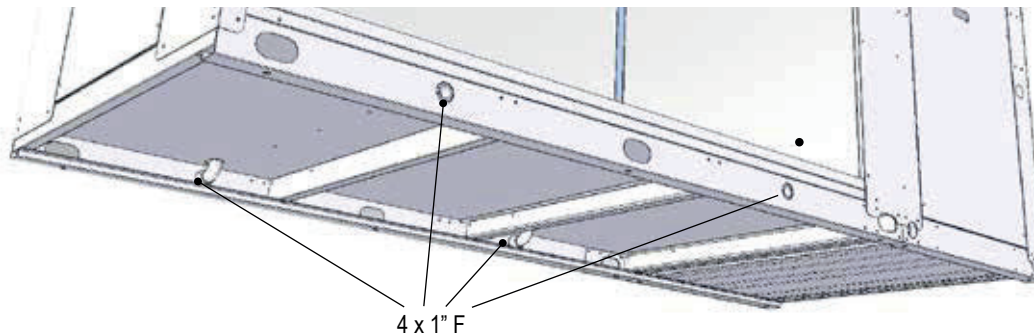

The condensate drain line should have a water trap which may have minimum flying height equal to the suction of the fan, in any case never less than 35 mm.

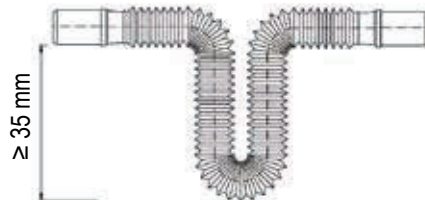

4.11.1 Installation of the heating cable



It is recommended that a heating cable be installed in the condensate drip tray discharge pipe to prevent freezing of the water inside the pipe itself, as this can lead to a malfunction of the unit.



The heating cable that is to be inserted in the discharge pipe must have a protection degree IP67 with a specific heating capacity of a minimum of 35W per linear metre. It is also recommended that the discharge pipe be insulated with closed cell type insulation having a minimum thickness of 15 mm.

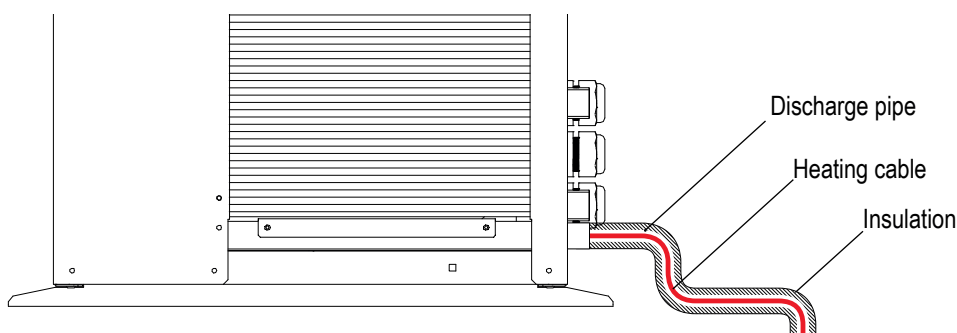

4.12 Hydraulic connections

The water pipe-work must be installed in accordance with national and local regulation and can be made from copper, steel, galvanized steel or PVC. The Pipework must be designed to cater for the nominal water flow and the hydraulic pressure drops of the system, a maximum pressure drop of 300 Pa/m run being typical. All pipes must be insulated with closed-cell material of adequate thickness. The hydraulic piping should includes:

- Pockets for temperature sensor to measure the temperature in the system.
- Flexible joints, to isolate the unit from the rest of the system.
- Temperature and pressure gauges for maintenance and servicing operations.
- Shut-off manual valves to isolate the unit from the hydraulic circuit.
- Metallic filters to be mounted on the inlet pipe with a mesh not larger than 1 mm (supplied as standard).
- Vent valves, expansion tank with water filling, discharge valve.



System return water must be fitted to the connection labelled: "USER WATER IN" as incorrect connection can damage the heat exchanger by freezing.



It is compulsory to install on the USER WATER IN connection, a water strainer with a mesh not larger than 1 mm. Fitting this filter is **COMPULSORY** and the warranty will be invalidated if it is removed. The filter must be kept clean and checked periodically.

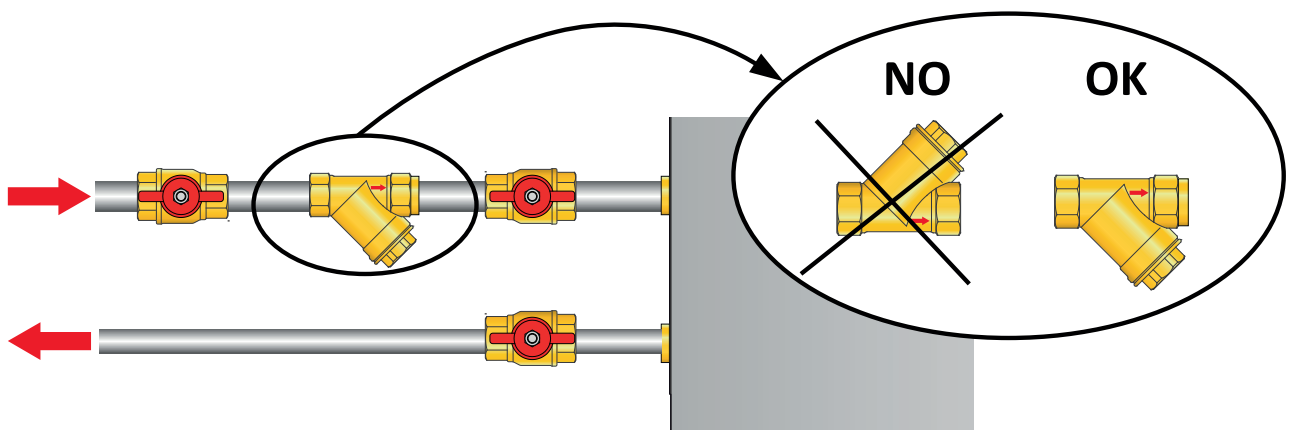

All units are factory supplied with a flow switch; the flow switch **MUST BE FITTED** in the pipework connection labelled "USER WATER OUT". If the flow switch is altered, removed, or the water filter omitted on the unit, the warranty will be invalidated.



The water flow through the heat exchangers of the unit should not be fall below Δt 8°C measured at the following conditions:

- Heating mode:** 7°C Dry bulb ambient temperature, 35°C water outlet temperature;
- Cooling mode:** 35°C dry bulb ambient temperature, 7°C water outlet temperature.

4.13 Chemical characteristics of the water

The system is to be filled with clean water and vented after a full flushing operation has been performed; the water should have the following characteristics :

PH	6-8	Total Hardness	Lower Than 50 ppm
Electric conductivity	Lower Than 200 mV/ cm (25°C)	Sulphur ion	None
Chlorine ions	Lower Than 50 ppm	Ammonia ion	None
Sulphuric acid ions	Lower Than 50 ppm	Silicon ion	Lower Than 30 ppm
Total Iron	Lower Than 0,3 ppm		

4.14 Hydraulic components

4.14.1 Standard Versions

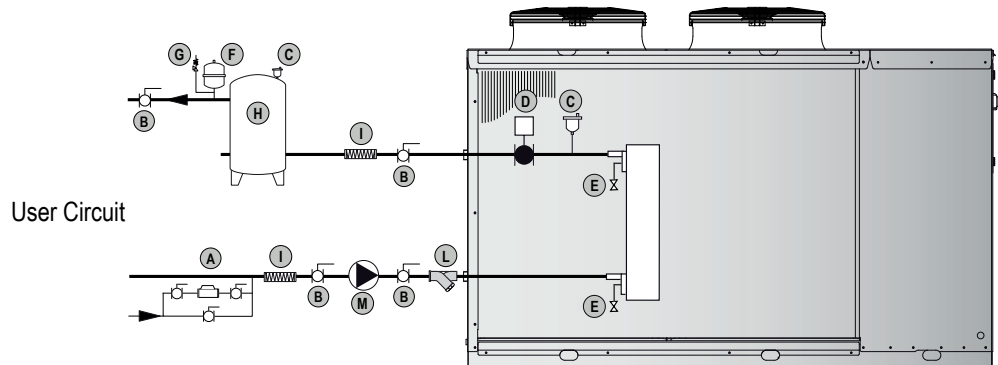

The water pump must be installed with the supply side toward the water inlet connection of the unit.

4.14.2 A1ZZU - A2ZZU

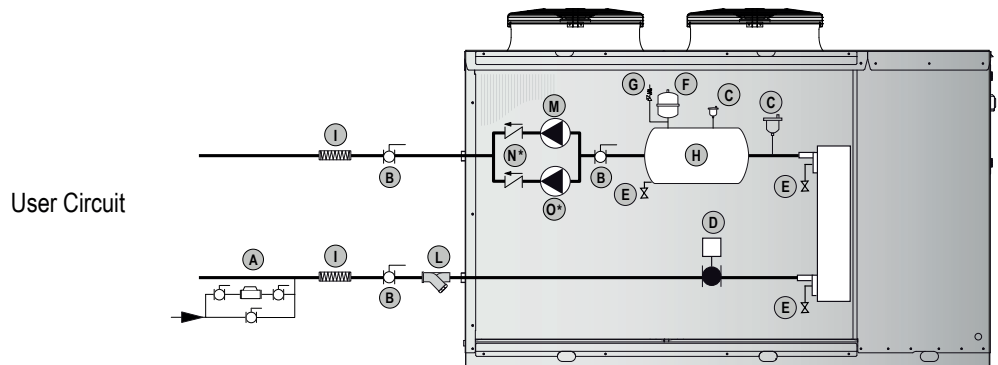

4.14.3 A1NTU - A2NTU

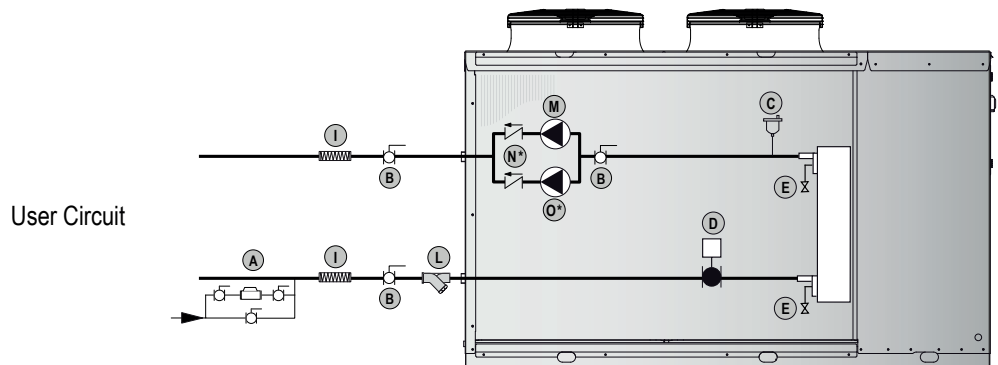

A	System Filling Group	H	User water tank
B	Shut-off Valve	I	Flexible Connection
C	Vent Valve	L	Water Strainer
D	Flow Switch	M	Water Pump
E	Drainage valve	N*	One way valve
F	Expansion Vessel	O*	Water Pump
G	Safety Valve		

Legend:

*Available for A2NTU – A2NTR – A2ZZU versions only; not available for A1NTU – A1NTR – A1ZZU)



Components shown inside the units are factory fitted.
Components shown outside of the units must be present in the system to guarantee the correct operation. The installation of those components is charged to the installer.

4.15 User circuit minimum water content



Heat pump units need a minimum water content inside the user circuit in order to guarantee the correct functioning of the unit. A correct water content reduces the n° of starts-and-stops of the compressors and this extends the operating life of the unit and allows a reduced reduction of the hot water temperature during the defrosting cycle. For these reason it's necessary to guarantee to the unit the following minimum water contents in the user circuit:
 Recommended water content : 15l/kW
 Recommended minimum water content : 20 lt. x Thermal power (kW) / Number of compressors.

Model	22	30	40	45	50	60	70	75	90	105	115	140
Minimum water content winter mode (l)	240	340	400	480	560	650	750	820	1000	1120	1240	1440

Model	150	170	180	210	240	230	270	300	340	365	410	465
Minimum water content winter mode (l)	1600	1800	1920	2000	2200	1230	1400	1530	1700	1970	2240	2420

4.16 Minimum domestic hot water circuit content

The minimum domestic hot water circuit content required is:

Model	22	30	40	45	50	60	70	75	90	105	115	140
Minimum water content hydraulic circuit (l)	240	340	400	480	560	650	750	820	1000	1120	1240	1440

Model	150	170	180	210	240	230	270	300	340	365	410	465
Minimum water content hydraulic circuit (l)	1600	1800	1920	2000	2200	1230	1400	1530	1700	1970	2240	2420



The minimum domestic hot water circuit content shown in the above table shows the minimum water content required by the system to guarantee the correct operation of the unit in terms of the acceptable number of starts of the compressors and the minimum allowed working time per cycle. **The above values do not guarantee the availability and temperature of domestic hot water**; the correct volume MUST be calculated based upon the domestic hot water system type and on the user requirements. Please contact technical support team for information regarding this.

4.17 Filling the hydraulic circuit

- Before filling, check that the installation drain valve is closed.
- Open all pipework, heat pump and terminal unit air vents.
- Open the shut off valves.
- Begin filling, slowly opening the water valve in the filling group outside the unit.
- When water begins to leak out of the terminal air vent valves, close them and continue filling until the pressure gauge indicates a pressure of 1.5 bars.

The installation should be filled to a pressure of between 1 and 2 bars. It is recommended that this operation be repeated after the unit has been operating for a number of hours (due to the presence of air bubbles in the system). The pressure of the installation should be checked regularly and if it drops below 1 bar, the water content should be topped-up. If frequent top-ups are required, check all connections for leaks.

4.18 Emptying the installation

- Before emptying, place the mains switch in the "Off" position.
- Make sure the filling group valve is closed.
- Open the drainage valve outside the unit and all the installation and terminal air vent valves.



If the fluid in the circuit contains anti-freeze, it MUST not be allowed to run away to drain. It must be collected for possible re-cycling or for correct disposal.

4.19 Typical installations

4.19.1 Combined heating / Cooling / Domestic hot water production – 2 pipe system

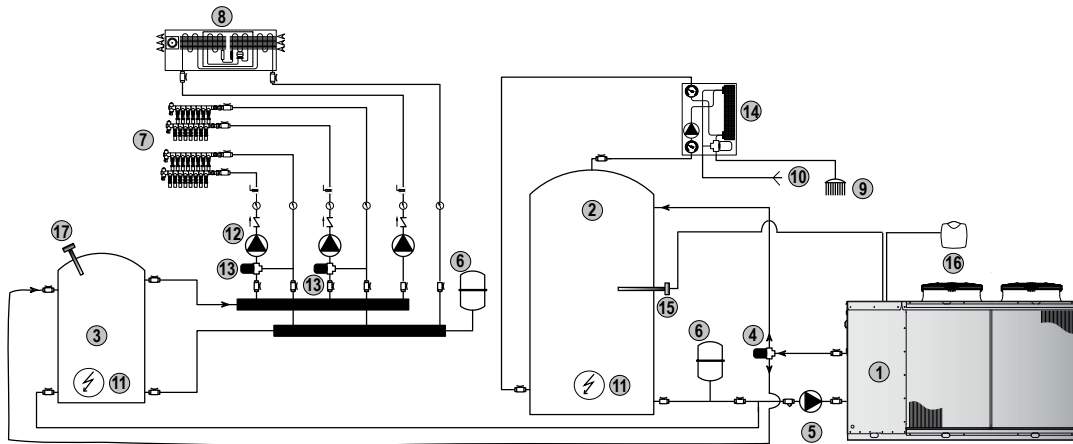

1	Heat pump	2	DHW Domestic hot water cylinder
3	Buffer storage tank	4	3 way ON/OFF valve Heating/DHW production
5	Primary circuit user water pump	6	Expansion vessel
7	Underfloor heating system	8	Dehumidifier / Cooling
9	Domestic hot water supply	10	Domestic cold water
11	Integration electric heater	12	Secondary circuit user water pumps
13	Underfloor heating modulating valves	14	Instantaneous domestic hot water producer
15	Domestic hot water sensor	16	Weather compensation sensor
17	User circuit sensor		

The above system combines heating at low temperatures with domestic hot water production at higher temperature using an instantaneous heat exchanger. When heating, the hot water produced by the heat pump is supplied to the floor heating at low temperatures e.g. 35°C. Domestic hot water production however, always has priority; it is activated by the domestic hot water sensor (15) which switches the position of the 3 way valve (4) and the set point of the unit e.g. 60°C. In cooling mode the system will produce cold water (by activation of the reversing valve). If domestic hot water is required, the unit stops the production of cold water, switches the reversing valve to heating, changes the position of the 3 way valve (4) and changes to the DHW set point. The heat pump heats up the DHW cylinder (2) and, when the temperature measured by the DHW sensor (15) reaches set point, it returns to operation in cooling mode. All units are supplied with a weather compensation sensor (16) that enables compensation of the hot water set point in winter mode with respect to the variation of ambient temperature.

The plant components supplied by the company are:

	STANDARD		OPTIONS		NOT AVAILABLE
1	Heat pump	2	Domestic hot water cylinder	4	3 way ON/OFF valve Heating/DHW production
15	Domestic hot water sensor	3	Buffer storage tank	6	Expansion vessel
16	Weather compensation sensor	4	3 way ON/OFF valve	7	Underfloor heating system
17	User circuit sensor	5	Primary circuit user water pump	9	Domestic hot water supply
		8	Dehumidifier/Cooling	10	Domestic cold water
		11	Integration electric heater	12	Secondary circuit user water pumps
		14	Domestic hot water producer	13	Underfloor heating modulating valve

4.20 Electric connections: preliminary safety information

The electric panel is located inside the unit at the top of the technical compartment where the various components of the refrigerant circuit are also to be found. To access the electrical board, remove the front panel of the unit:



Power connections must be made in accordance to the wiring diagram enclosed with the unit and in accordance to the norms in force.



Make sure the power supply upstream of the unit is (blocked with a switch). Check that the main switch handle is padlocked and it is applied on the handle a visible sign of warning not to operate.



It must be verified that electric supply is corresponding to the unit electric nominal data (tension, phases, frequency) reported on the label in the front panel of the unit.



Power cable and line protection must be sized according to the specification reported on the form of the wiring diagram enclosed with the unit.



The cable section must be commensurate with the calibration of the system-side protection and must take into account all the factors that may influence (temperature, type of insulation, length, etc.).



Power supply must respect the reported tolerances and limits: If those tolerances should not be respected, the warranty will be invalidated.



Flow switches must be connected following the indication reported in the wiring diagram. Never bridge flow switches connections in the terminal board. Guarantee will be invalidated if connections are altered or not properly made.



Make all connections to ground provided by law and legislation.



Before any service operation on the unit, be sure that the electric supply is disconnected.



The power line and the unit external safety devices must be sized in order to ensure the correct voltage at the maximum operating conditions of the unit reported in the wiring diagram of the unit.



FROST PROTECTION

If opened, the main switch cuts the power off to any electric heater and antifreeze device supplied with the unit, including the compressor crankcase heaters. The main switch should only be disconnected for cleaning, maintenance or unit repair.

4.21 Electric data



The electrical data reported below refer to the standard unit without accessories.
In all other cases refer to the data reported in the attached electrical wiring diagrams.



The line voltage fluctuations can not be more than $\pm 10\%$ of the nominal value, while the voltage unbalance between one phase and another can not exceed 1%, according to EN60204. If those tolerances should not be respected, please contact our Company.

Model		22	30	40	45	50	60	70	75
Power supply	V/~/Hz	400/3+N/50	400/3+N/50	400/3+N/50	400/3/50	400/3/50	400/3/50	400/3/50	400/3/50
Control board	V/~/Hz	24 V	24 V	24 V	24 V	24 V	24 V	24 V	24 V
Auxiliary circuit	V/~/Hz	230/1/50	230/1/50	230/1/50	230/1/50	230/1/50	230/1/50	230/1/50	230/1/50
Fans power supply	V/~/Hz	230/1/50	230/1/50	230/1/50	400/3/50	400/3/50	400/3/50	400/3/50	400/3/50
Line section	mm ²	10	16	16	16	25	25	35	35
PE section	mm ²	6	10	10	10	16	16	25	25

Model		90	105	115	140	150	170	180	210
Power supply	V/~/Hz	400/3/50	400/3/50	400/3/50	400/3/50	400/3/50	400/3/50	400/3/50	400/3/50
Control board	V/~/Hz	24 V	24 V	24 V	24 V	24 V	24 V	24 V	24 V
Auxiliary circuit	V/~/Hz	230/1/50	230/1/50	230/1/50	230/1/50	230/1/50	230/1/50	230/1/50	230/1/50
Fans power supply	V/~/Hz	400/3/50	400/3/50	400/3/50	400/3/50	400/3/50	400/3/50	400/3/50	400/3/50
Line section	mm ²	50	70	70	70	95	120	120	150
PE section	mm ²	25	35	35	35	50	70	70	70

Model		240	230	270	300	340	365	410	465
Power supply	V/~/Hz	400/3/50	400/3/50	400/3/50	400/3/50	400/3/50	400/3/50	400/3/50	400/3/50
Control board	V/~/Hz	24 V	24 V	24 V	24 V	24 V	24 V	24 V	24 V
Auxiliary circuit	V/~/Hz	230/1/50	230/1/50	230/1/50	230/1/50	230/1/50	230/1/50	230/1/50	230/1/50
Fans power supply	V/~/Hz	400/3/50	400/3/50	400/3/50	400/3/50	400/3/50	400/3/50	400/3/50	400/3/50
Line section	mm ²	185	185	185	185	240	240	2x150	2x240
PE section	mm ²	90	90	90	90	120	120	150	240



Electric data may change for updating without notice. It is therefore necessary to refer always to the wiring diagram present in the units.

4.22 Electric connections

4.22.1 Power supply and electrical connections

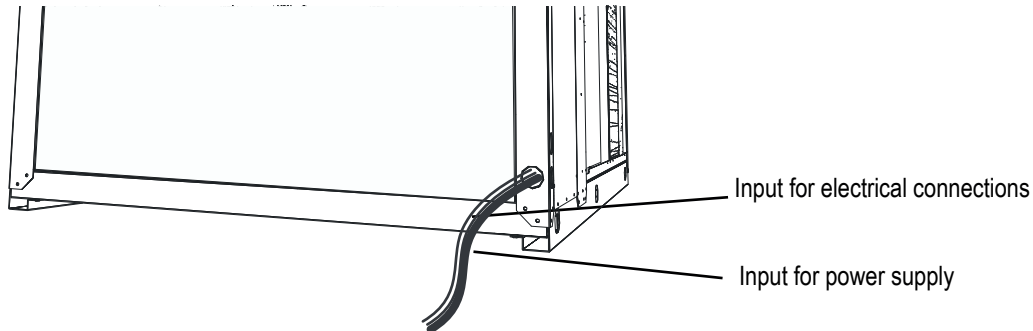

4.22.2 Remote wiring connections (compulsory)

All terminals referred to in the explanations below will be found on the terminal board inside the electrical box. All electric connections mentioned below have to be made by the installer, on site.

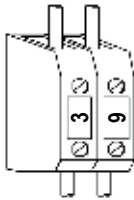

USER CIRCUIT WATER INLET SENSOR (BTI)

It is used to measure the return water temperature from the user circuit. The standard working mode has the user pump switched off during stand-by periods (Compressors Off). The sensor must be placed in an appropriate position in order to measure the temperature of the secondary circuit. Incorrect positioning of the user water sensor can adversely affect the operation of the heat pump. The remote sensor is supplied loose with the unit (it is present inside the electric box) and it is supplied with a 3 mt. cable length. If this is too short, it is possible to increase the length by using cable of diameter 0.5 mm² up to a maximum distance of 50 meters.

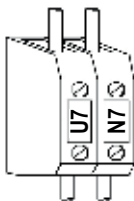

USER CIRCUIT WATER PUMP

If the pump is factory supplied and fitted (A version) it will already be connected otherwise, connect to terminals U7 and N7; maximum input current 3A. In standard configuration, the unit microprocessor controller switches off the user water pump when the set point is reached or if the unit is in standby. This strategy is suitable if the unit is heating a buffer store from which a secondary circuit is taken and provides a substantial reduction of energy use.

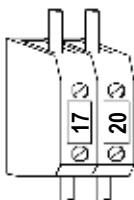

DOMESTIC HOT WATER SENSOR (BTS)

This is used to measure the return water temperature from the domestic hot water circuit. The sensor must be placed in the pocket provided in the DHW (Domestic hot water) cylinder, in an appropriate position, in order to measure the correct temperature of the domestic hot water. Incorrect positioning of the domestic hot water sensor can have an adverse effect on the operation of the heat pump. The sensor is supplied loose with the unit (it is placed inside the electric box) and it is supplied with a 3 mt. cable length. If this is too short, it is possible to increase the length by using cable of diameter 0.5 mm², up to a maximum distance of 50 meters.



The numbering of the terminals may change without notice. For their connection is mandatory to refer to the wiring diagram supplied along with the unit.

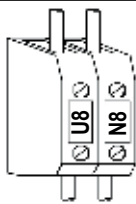

DOMESTIC HOT WATER CIRCUIT PUMP

To be connected across terminals U8 and N8; maximum input current 1A. In standard configuration, the microprocessor control of the unit switches off the user water pump when the set point has reached or if the unit is in standby. This strategy provides a substantial reduction of energy use.

4.22.3 Remote wiring connections (optional)

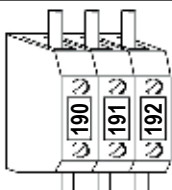

3 WAY ON/OFF VALVE(Only required on 2 pipes systems versions); Not required on /P4 versions)

The 3 way valve is used with 2 pipe systems to produce domestic hot water; the valve is activated by the Domestic hot water sensor (BTS) and diverts the hot water either to the domestic hot water cylinder or to the user circuit. The valve is connected across terminals 191/193/192.

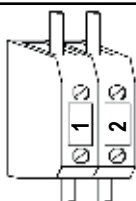

REMOTE ON / OFF

To switch the unit on or off remotely, the cable jumper connected across terminals 1 and 2 must be replaced with a switch.
 Contact closed, unit ON,
 Contact open, unit OFF.

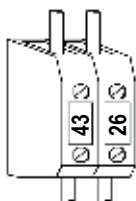

REMOTE SUMMER / WINTER CHANGE OVER

To remotely switch the unit from heating to cooling, the cable jumper connected across terminals 50 and 49 must be replaced with a switch.
 Contact closed, unit in Winter mode,
 Contact open, unit Summer mode.

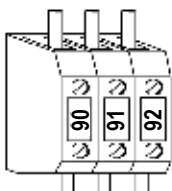

REMOTE GENERAL ALARM

For remote display of a general alarm, connect the visual or audible device between terminals 90-91-92.
 Contacts 90/91 NC (Normally closed)
 Contacts 91/92 NO (Normally opened)

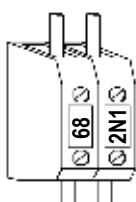

USER CIRCUIT ELECTRIC INTEGRATION HEATERS

If user circuit integration heaters are required, the coil of the contactor that is used to switch them must be connected across terminals 78 and 2N1.

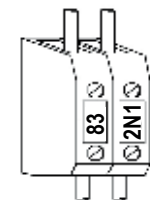

DOMESTIC HOT WATER ELECTRIC INTEGRATION HEATERS

If domestic hot water circuit integration heaters are required, the coil of the contactor that is used to switch them must be connected across terminals 93 and 2N1.



The numbering of the terminals may change without notice. For their connection is mandatory to refer to the wiring diagram supplied along with the unit.

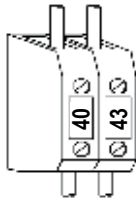

PRIORITY SELECTOR (Hot water) (only for sizes 22÷240)

If a priority selector switch is to be fitted, a voltage free switch has to be connected to terminals 50 and 57. The selector operates as follows:

Closed contact: Domestic hot water only;

Opened contact: Domestic hot water / Heating (and / or cooling);

The unit is supplied with nothing connected to terminals 50 and 57 (Open contact).

(Models with neutral) (Other models)

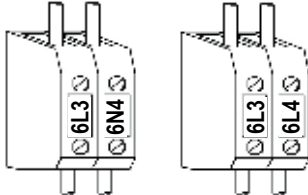

HEATING CABLE

This is used to prevent freezing of the condensate produced, in the outlet of the drain tray.

The maximum current must not exceed 0.5 A relating to a maximum power of 100 W. It is connected to terminals 6L3/6L4 (Modd 22÷40) and 150/154 (Modd 45÷465) (this heating cable is operated in conjunction with the electric heater in the condensate drain tray).

4.22.4 Factory fitted wiring connections

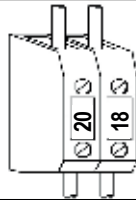

WEATHER COMPENSATED SENSOR (BTE)

This is used to measure the ambient temperature enabling weather compensation modulation of the user set point with respect to the ambient conditions. It is connected to terminals 11 and 7.

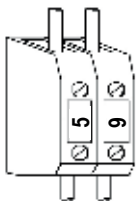

DOMESTIC HOT WATER OUTLET SENSOR (BTU)

This is used to measure the domestic hot water outlet temperature; it is also used as maximum temperature sensor to protect the refrigerant circuit of the unit from excessive temperatures in case of low water flow rates. The sensor is connected to terminals 7 and 5.

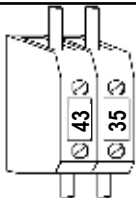

USER CIRCUIT FLOW SWITCH (SFW1)

This is used to protect the unit if there is a low water flow rate in the user circuit. It is factory fitted across terminals 50 and 45.



The numbering of the terminals may change without notice. For their connection is mandatory to refer to the wiring diagram supplied along with the unit.

4.23 Positioning of the user circuit water inlet sensor (BTI)

The correct positioning of the BTI sensor is extremely important to guarantee the correct operation of the heat pump. The BTI sensor is used to cycle the unit to maintain the user water temperature at set point. The BTI sensor is also used to activate the user water pump and to stop it when the user water temperature set point is reached.



To guarantee the correct measurement of the temperature insert the probe in the sensor pocket of the buffer tank.

Correct positioning of the BTI sensor

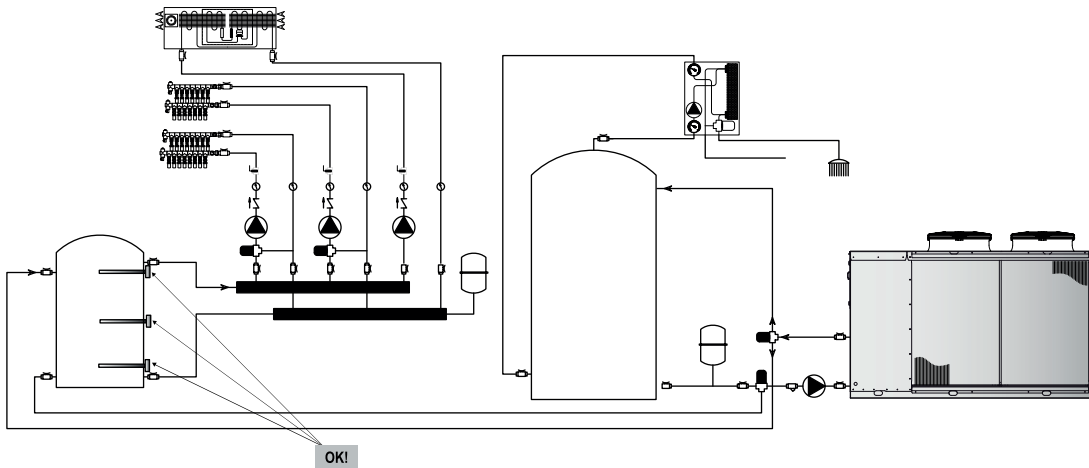

Incorrect positioning of the BTI sensor

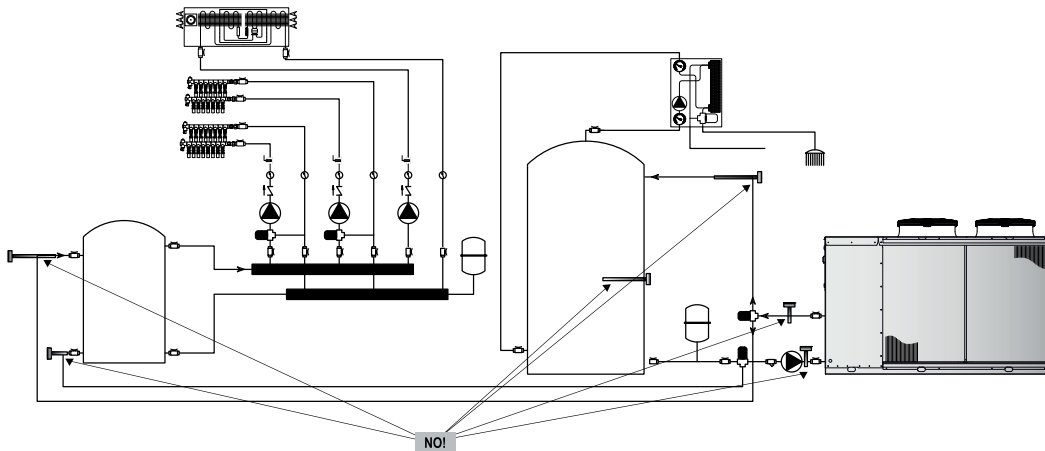

4.24 Positioning of the domestic hot water circuit sensor (BTS)

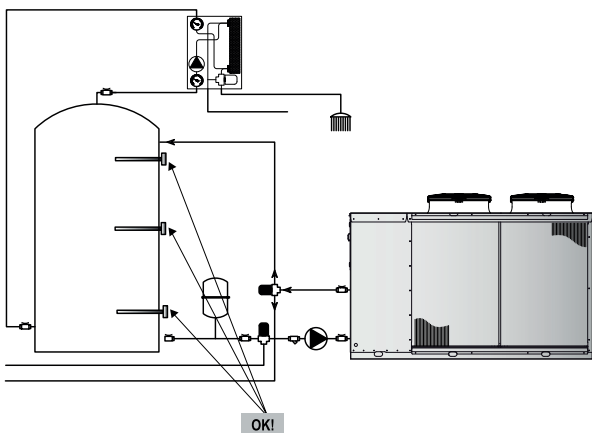

Correct positioning of the BTS sensor

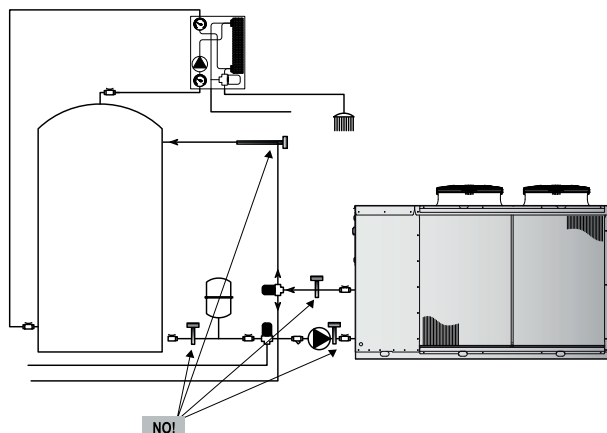

Incorrect positioning of the BTS sensor

4.25 Refrigerant circuit layout

4.25.1 Refrigerant circuit layout version SE - SE/ACF - single finned coil



Without DHW option

This is a two pipe version that can produce hot water for heating and cold water for cooling. The unit is used with two pipe water based change-over systems. It is not able to produce domestic hot water.



With DHW option

This is a two pipe version that can, in addition to producing hot water for heating and cold water for cooling, also generate domestic hot water. The controller has dual heating set points (heating and DHW) and can also control a three port diverting valve that directs the DHW to the cylinder. DHW production has priority irrespective of the mode of operation of the unit. The unit is normally used with two pipe water based change-over systems.

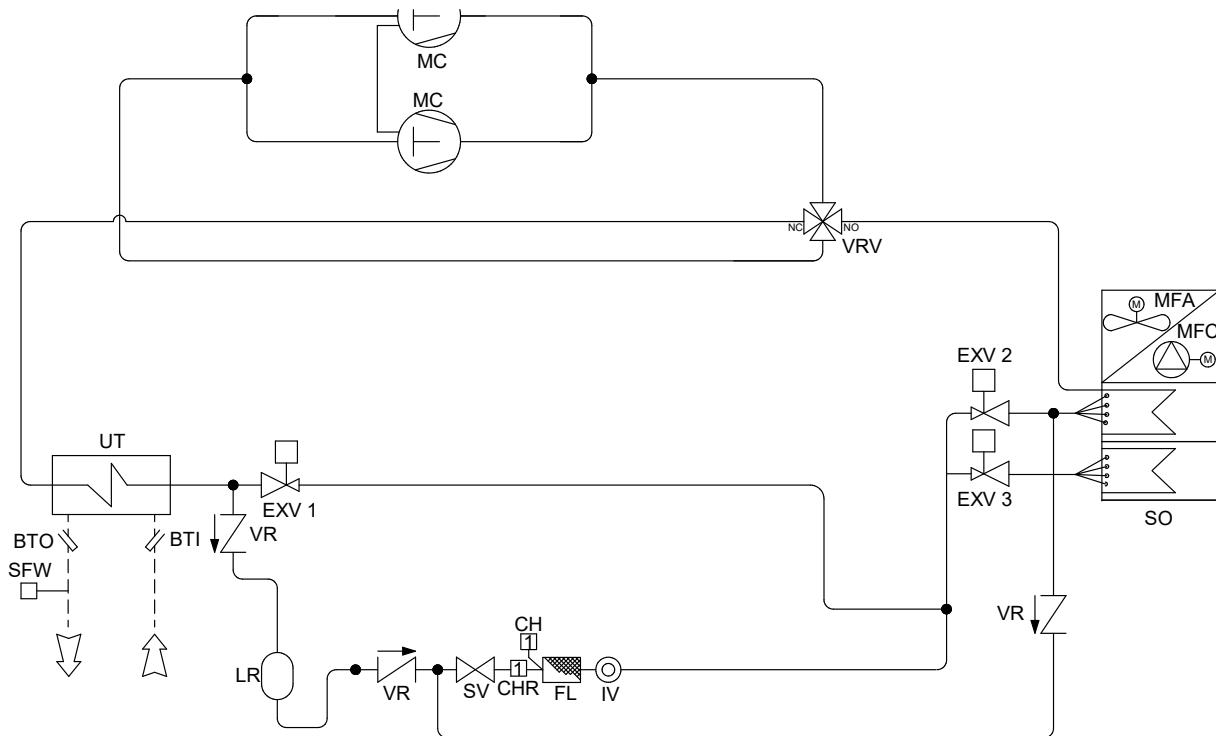

Basically, the refrigerator diagram is purely indicative. The functional diagram is supplied with the unit.



Models 230-270-300-340-365-410-465, in all versions, use two independent refrigerant circuits identical to the one shown above.

BTI	User water input probe	MFC	Centrifugal fan
BTO	User water output probe	SFW	User flow switch
CH	Charging plug	SO	Source side
CHR	Charging plug	SV	Shut off valve
ECO	Economizer	UT	User side
EXV	Thermostatic valve	VR	Check valve
FL	Liquid line filter	VRV	Reverse cycle valve
IV	Moisture indicator sight glass	YEC	By-pass solenoid valve
LR	Liquid receiver	—	Refrigeration connections
MC	Compressor	—	Hydraulic connections
MFA	Source fan		

4.25.4 Refrigerant circuit layout version STD/ACF - double finned coils



Without DHW option

This is a two pipe version that can produce hot water for heating and cold water for cooling. The unit is used with two pipe water based change-over systems. It is not able to produce domestic hot water.



With DHW option

This is a two pipe version that can, in addition to producing hot water for heating and cold water for cooling, also generate domestic hot water. The controller has dual heating set points (heating and DHW) and can also control a three port diverting valve that directs the DHW to the cylinder. DHW production has priority irrespective of the mode of operation of the unit. The unit is normally used with two pipe water based change-over systems.

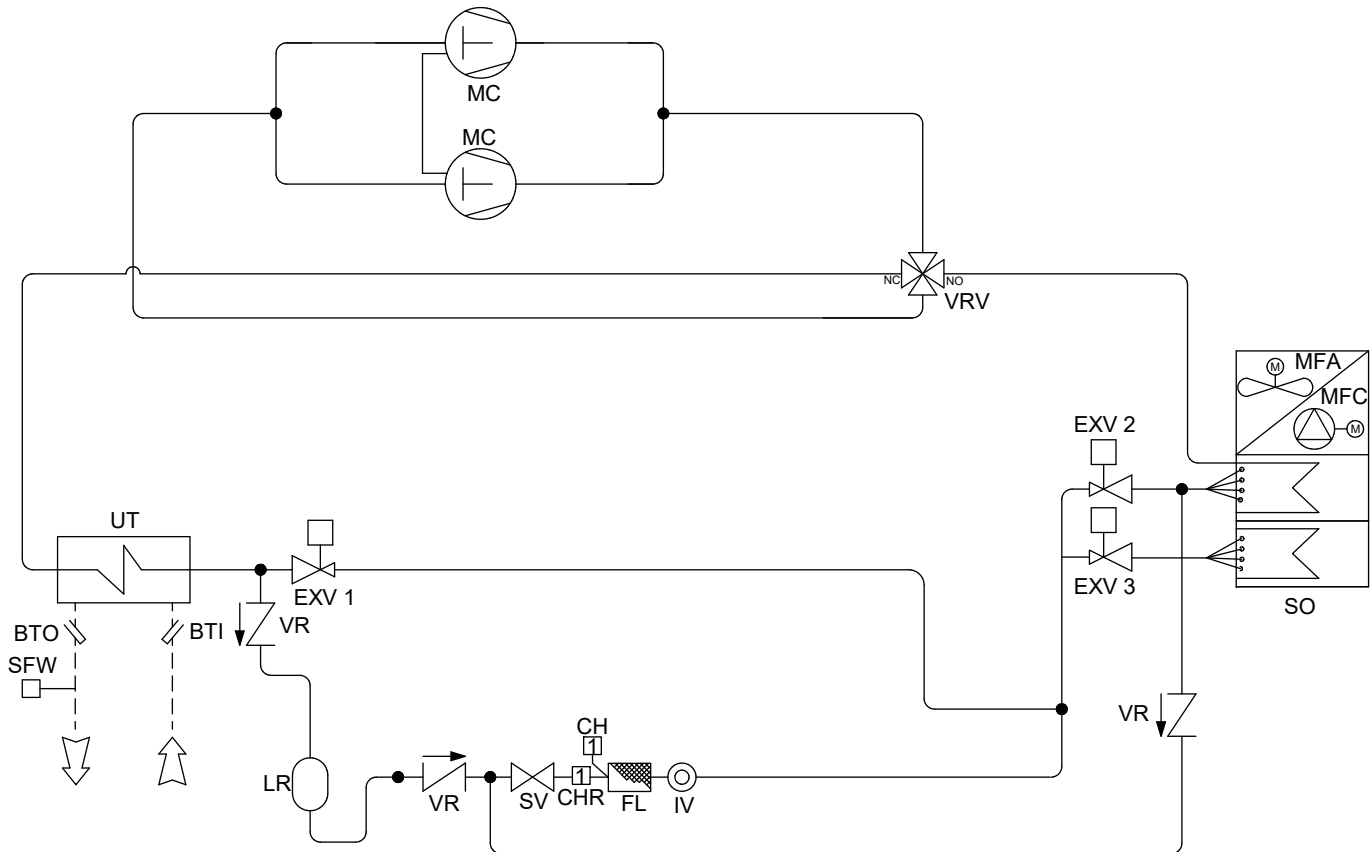

Basically, the refrigerator diagram is purely indicative. The functional diagram is supplied with the unit.

BTI	User water input probe	MFC	Centrifugal fan
BTO	User water output probe	SFW	User flow switch
CH	Charging plug	SO	Source side
CHR	Charging plug	SV	Shut off valve
ECO	Economizer	UT	User side
EXV	Thermostatic valve	VR	Check valve
FL	Liquid line filter	VRV	Reverse cycle valve
IV	Moisture indicator sight glass	YEC	By-pass solenoid valve
LR	Liquid receiver	—	Refrigeration connections
MC	Compressor	--	Hdraulic connections
MFA	Source fan		

5. UNIT START UP

5.1 Preliminary checks

Before starting the unit the checks detailed in this manual of the electric supply and connections (par. 4.20), the hydraulic system (par. 4.11) and the refrigerant circuit (par. 5.1.4), should be performed.



Start-up operations must be performed in accordance with the instructions detailed in the previous paragraphs.



If it is required to switch the unit on and off, never do this using the main isolator: this should only be used to disconnect the unit from the power supply when the unit is to be permanently off. Isolation will result in no supply for the crankcase heater and on start up the compressor could be seriously damaged.

5.1.1 Before start-up



Damage can occur during shipment or installation. It is recommended that a detailed check is made, before the installation of the unit, for possible refrigerant leakages caused by breakage of capillaries, pressure switch connections, tampering of the refrigerant pipework, vibration during transport or general abuse suffered by the unit.

- Verify that the unit is installed in a workmanlike manner and in accordance with the guidelines in this manual.
- Check that all power cables are properly connected and all terminals are correctly fixed.
- The operating voltage between phases R S T is the one shown on the unit labels.
- Check that the unit is connected to the system earth.
- Check that there is no refrigerant leakage.
- Check for oil stains, sign of a possible leak.
- Check that the refrigerant circuit shows the correct standing pressure on the pressure gauges (if present) otherwise use external ones.
- Check that the Schrader port caps are the correct type and are tightly closed.
- Check that crankcase heaters are powered correctly (if present).
- Check that all water connections are properly installed and all indications on unit labels are observed.
- The system must be flushed, filled and vented in order to eliminate any air.
- Check that the water temperatures are within the operation limits reported in the manual.
- Before start up check that all panels are replaced in the proper position and locked with fastening screws.



Do not modify internal wiring of the unit as this will immediately invalidate the warranty.



Crankcase heaters must be powered at least 12 hours before start up (pre-heating period) To do this, isolate the compressor(s), fans and pump(s) in the electrics box and then switch on the main isolator (heaters are automatically supplied when the main switch is closed). The crankcase heaters are working properly if, after several minutes, the compressor crankcase temperature is about 10÷15°C higher than ambient temperature.



During the 12 hours pre-heating period it is also important to check that the label OFF is shown on the display or that the unit is on stand-by mode. If there is an accidental start-up before the 12 hours pre-heating period has elapsed, the compressors could be seriously damaged and therefore the warranty will immediately terminate .

5.1.2 Device Set-point Differential Reset

Device		Set-point	Differential	Reset
Heating mode	°C	35	2	----
Domestic hot water mode	°C	50	2	----
Cooling mode	°C	23	2	----
Anti-freeze thermostat	°C	4,5	4	MANUAL
High pressure switch	Bar	45	7	Automatic for 3 times (than manual)
Low pressure switch	Bar	5,7	1,3	
Water safety valve (Present in A versions only)	Bar	6,0		Automatic



If the unit is required for heating/cooling only (without domestic hot water production) the internal parameter of the microprocessor FS1 has to be modified from 2 to 1 in order to avoid configuration alarms. Please contact the company for support.

5.1.3 Controls during unit operation

- Check the rotation of the compressors and fans. If the rotation is incorrect, disconnect the main switch and change over any two phases of the incoming main supply to reverse motor rotation (only for units with three-phase fan motors).
- After several hours of operation, check that the sight glass has a green colour core: if the core is yellow moisture is present in the circuit. In this event it is necessary for dehydration of the circuit to take place. This must be performed by qualified people only. Check that there are no continuous vapour bubbles present at the sight glass. This would indicate a shortage of refrigerant. A few vapour bubbles are acceptable.
- Few minutes after start up, check that the equivalent temperature of the refrigerant gas, measured at the pressure inside the finned coil with fans running at full speed, differs from the outside air temperature of about 7-10°C; also verify that the equivalent temperature of the refrigerant gas, measured at the pressure in the plate heat exchanger, differs from the temperature of the water outlet from the exchanger of about 3-5°C .

5.2 Position of the control panel



5.3 Description of the control panel

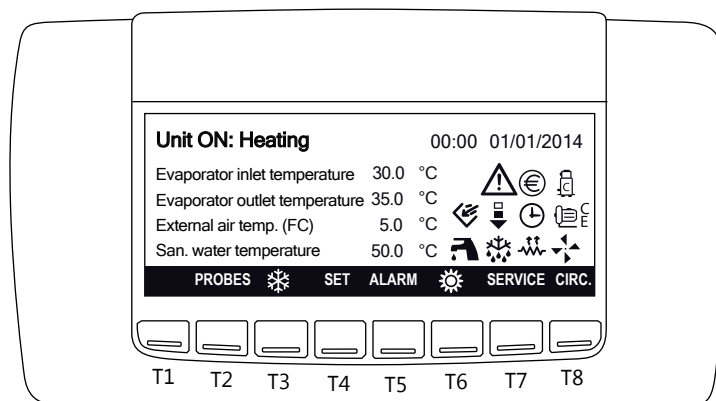

5.3.1 Display icons

Icon	Meaning	Icon	Meaning
	Number of compressors in operation.		Indicates that the electric heaters are active.
	Water pump		Economy or ON/OFF by timetable.
	Indicates that the fans are working.		Free cooling is active (not available).
	Indicates that an alarm is active.		Domestic hot water.
	Economy function		Indicates that the defrost is active.
	Unloading function (not available).		

5.3.2 Key function

T2:	PROBES	Allows to read the value of the probes configured
T3:		Allows to switch on the unit in cooling mode
T4:	SET	Allows to read and modify the set point
T5:	ALARM	Allows to read and reset the alarms
T6:		Allows to switch on the unit in heating mode
T7:	SERVICE	Allows to enter the SERVICE menu
T8:	CIRC	Allows to read the main information of the circuits (compressor status, water pump status, pressure probe value,...)

When the unit is turned on, the display will be as follows:

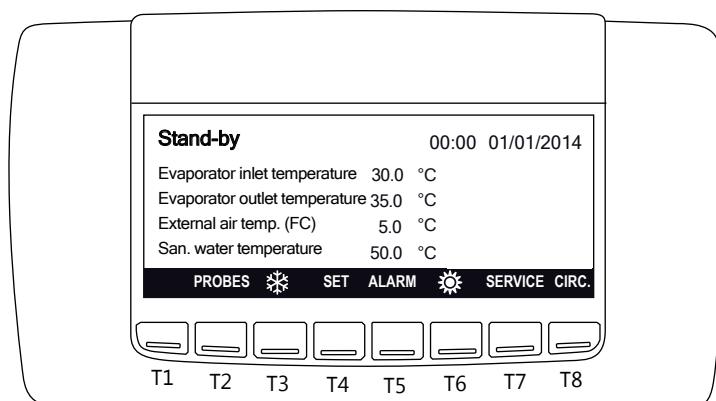

5.4 To remote the control

5.4.1 Remote keyboard connection (VGI890)

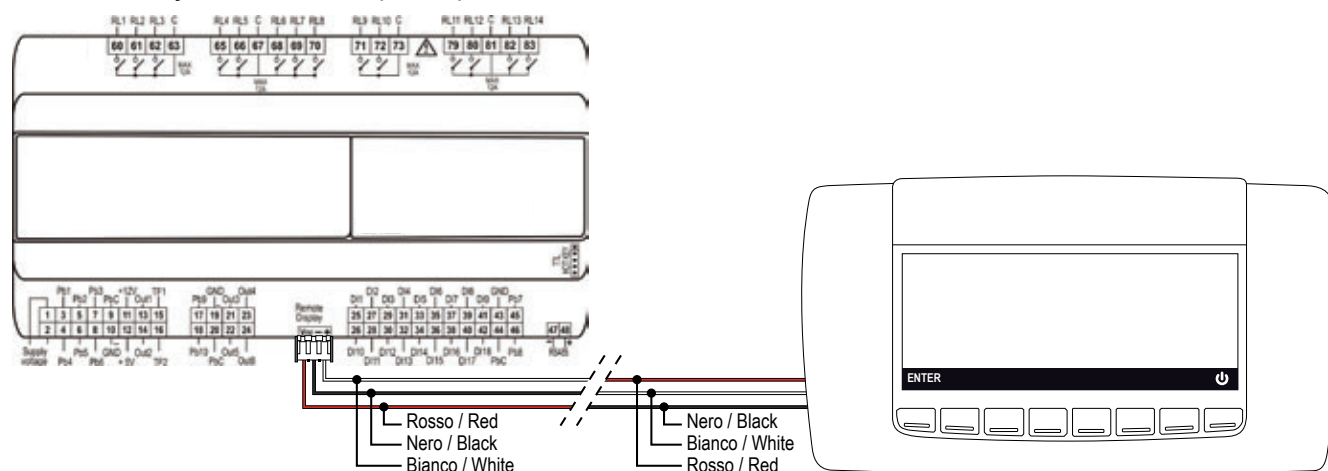

Special care must be taken when connecting the keyboard to the IChill200D, to avoid irreparable damage to the controller or/and keyboard

- In case of power supply failure (wire black or red), the keyboard doesn't work.
- In case of communication problems, the display shows "noL" message.

5.4.2 Panel mounting connection diagram

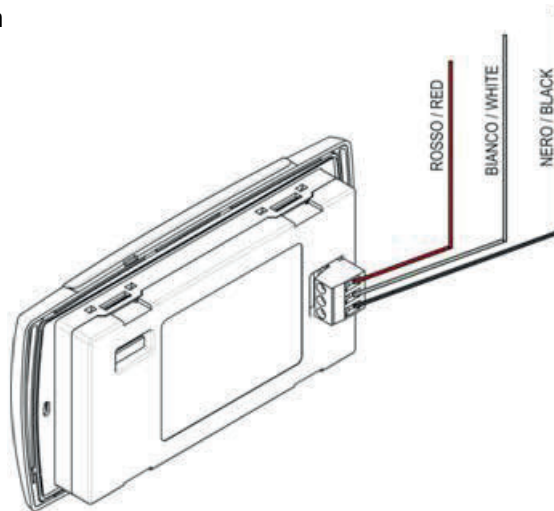

5.4.3 Wall mounting connection diagram

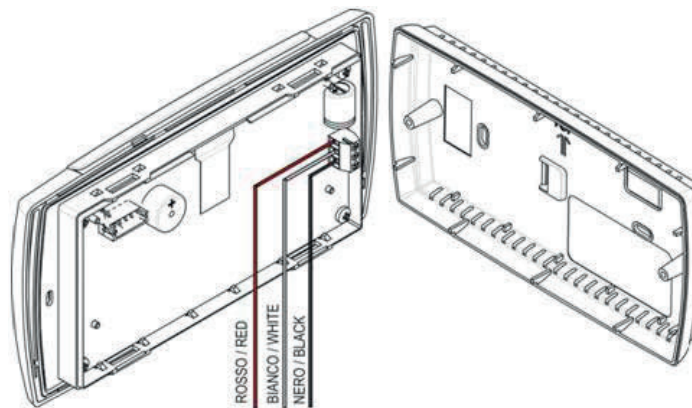

5.4.4 Selection built in display or remote keyboard

Use the selector switch as shown below to choose the desired display:

- Position 0 = display on board
- Position 1 = remote display.



For remote display electrical connections, always refer to the electrical diagram supplied with the unit.

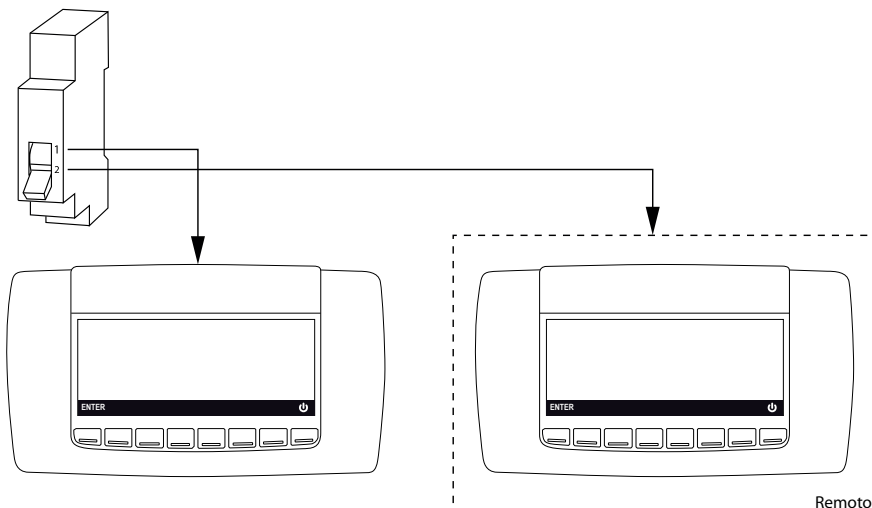

6. USE

6.1 Switch the unit on

Unit switch-on and switch-off can take place:

- From the keyboard
- From digital input configured as remote ON/OFF



Before first start-up, consult and carry out the operations described in the paragraph “ Periodical checks “.

6.1.1 Switch the unit on from the keyboard

Cooling mode

To start the unit in the cooling mode, press the  key. The icon  appears on the display.

If requested, the compressor safety delay countdown starts and the compressor icon flashes. The water pump will be activated after few seconds, and then, once the compressor countdown has finished, the compressor starts and the icon remains on. The display shows the user water inlet temperature and Domestic hot water inlet temperature.

Heating mode

To start the unit in heating mode, press the  key. The icon  appears on the display.

If requested, the compressor safety delay countdown starts and the compressor icon flashes. The water pump will be activated after few seconds and then, once the compressor countdown has finished, the compressor starts and the icon remains on. The display shows the user water inlet temperature and Domestic hot water inlet temperature.

Domestic hot water mode

At the first start up, the unit microprocessor control checks the domestic hot water inlet temperature measured by the sensor BTS (this has priority over the other parameters) and, if the measured temperature is lower than the domestic hot water set point , it will activate the domestic hot water mode automatically. If the unit is required to operate in heating and the domestic hot water temperature is higher than the set point (there is no requirement for domestic hot water) the microprocessor control will activate the unit in heating mode. If the unit is required to operate in cooling and domestic hot water mode the microprocessor control will activate both functions at the same time. If domestic hot water is not required, the microprocessor control will activate cooling mode only.

In stand-by mode, the controller gives the possibility to:

- display the set values
- manage alarms, theyr display and reports.



If it is required to switch the unit on and off, never do this using the main isolator: this should only be used to disconnect the unit from the power supply when the unit is to be permanently off. Isolation will result in no supply for the crankcase heater and on start up the compressor could be seriously damaged.

6.1.2 Heating and cooling mode

The display shows the typical visualization during the unit working in:

HEATING MODE

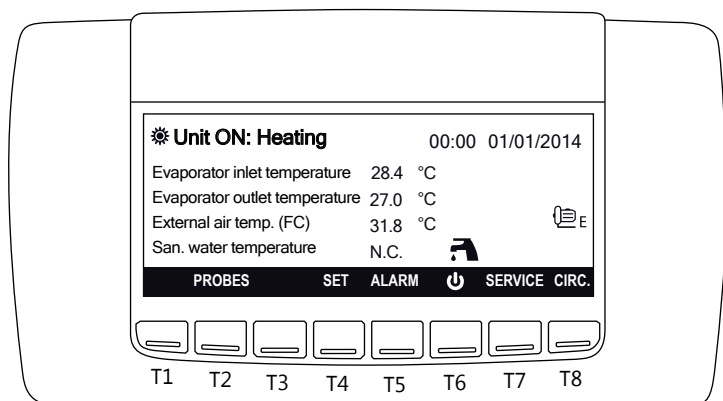

COOLING MODE

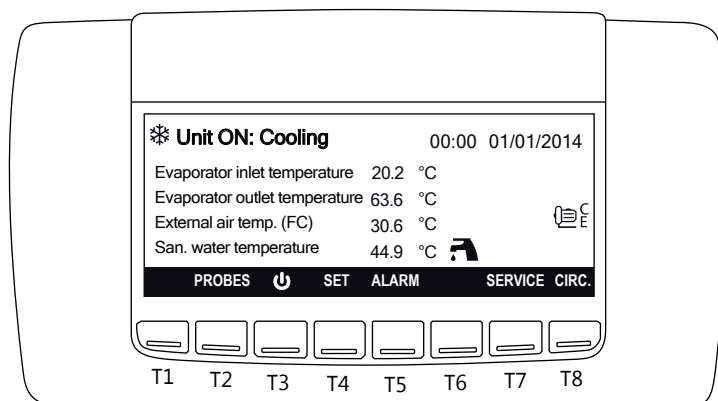

6.1.3 Switch the unit on from from digital input

If the unit is switch off by remote digital input, the display shows:

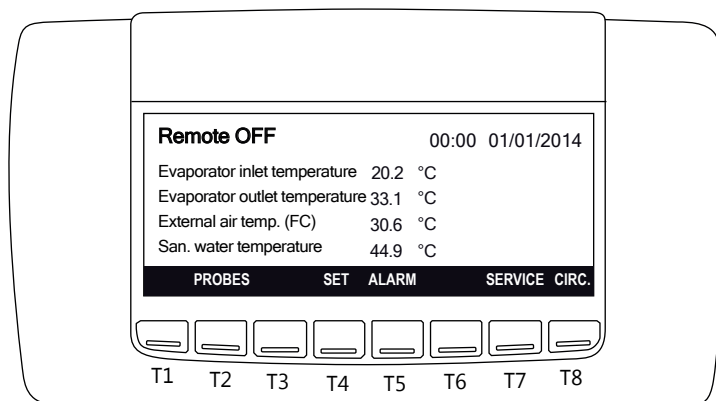

When the digital input is not active, the unit is in OFF mode

- The remote input has the priority with respect to the keyboard
- The unit can only be switched-on and off if the remote input is activated

6.2 Stop

To switch the unit off press the key .

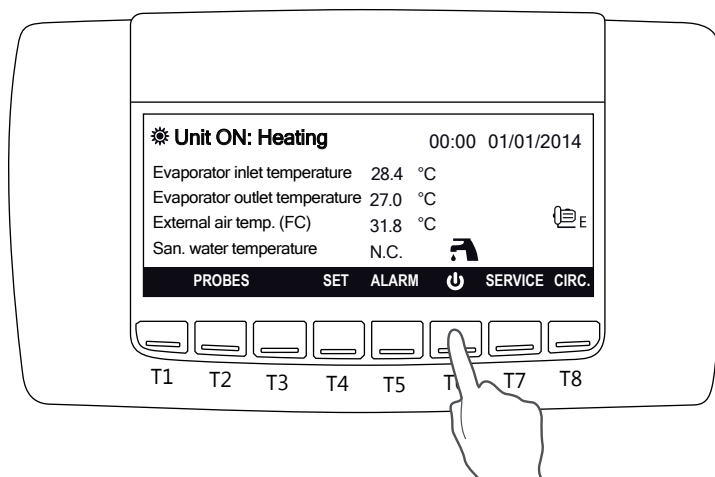

6.3 Set point

To change the set-point from the main screen, press **SET** .

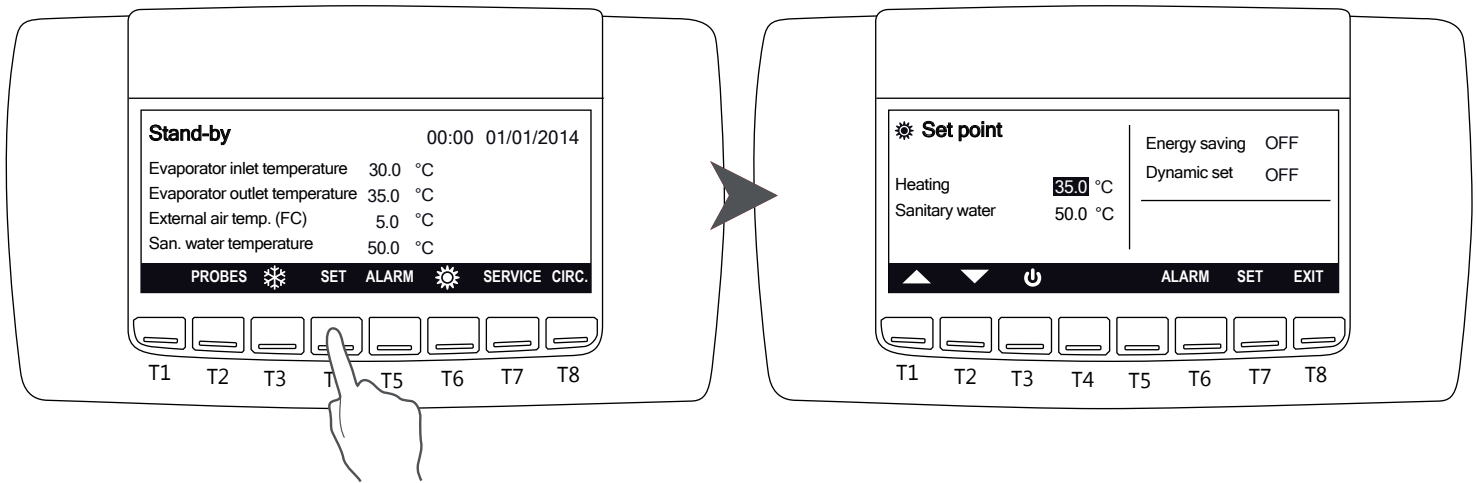

To modify the values, move the cursor with ; press **SET** to select, the value starts blinking, change the data pressing and . Once the required value is reached, press again **SET** to confirm.

The cursor will automatically position itself on the next value, to modify it, repeat the operation just described.

In this screen it is also possible to verify (but not modify) whether the energy saving mode and dynamic set are active.

Press **EXIT** to go back to the main menu.



All set points refer to the return temperature from the plant. In case hot water at 45°C is requested and the Δt is 5°C, then the set point must be set at 40°C. In case the Δt is 8°C, then the set point must be set at 37°C. In case cold water is requested, for example at 15°C and the Δt is 5°C, then the set point must be set at 20°C. If the Δt is 8°C, then the set point must be set at 23°C.

6.3.1 Adjustable parameters

The adjustable set point that can be modified by the end user are:

Function	Adjustment limit	Default value
Heating set-point	10÷55°C	35°C
Domestic hot water set-point	20÷55°C	50°C
Cooling set-point	10÷25°C	23°C
Set point compensation	0÷15°C	10°C
Password	(Contact the company)	



The units are supplied with a very sophisticated control system with many other parameters that are not adjustable by the end user; these parameters are protected by a manufacturer password.

6.4 PROBES key

To view all the parameters measured by the sensors of the unit press **PROBES** ;

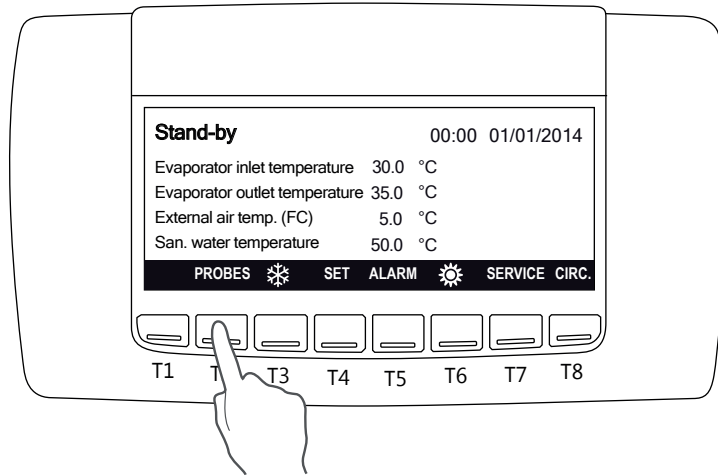

By pressing the key, all relevant values of the circuit will be displayed

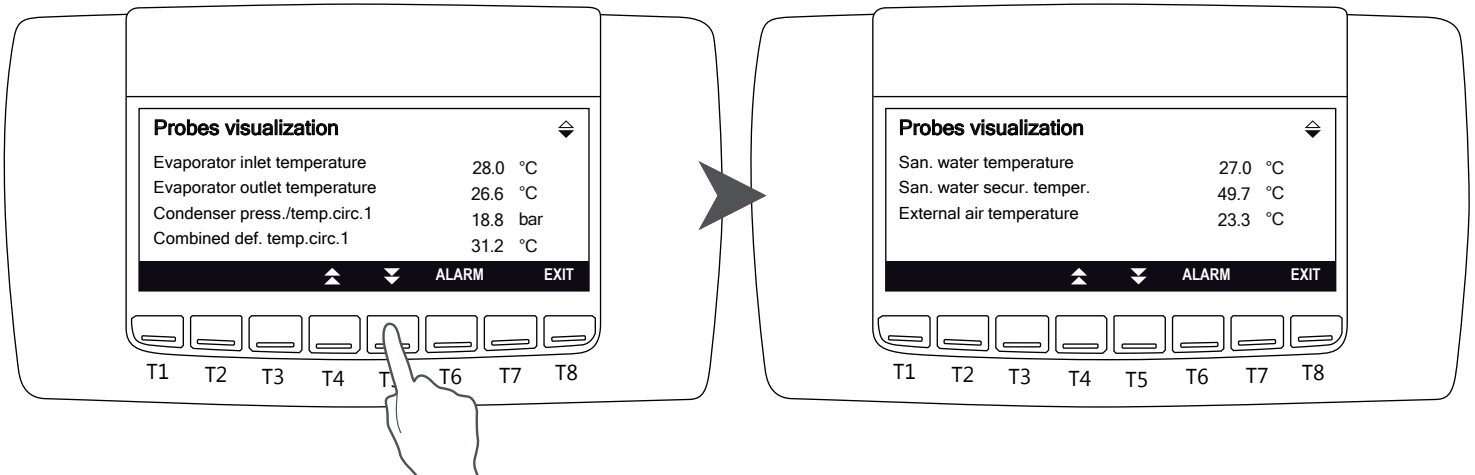

Press **EXIT** to go back to the main menu.

6.5 ALARM key

When the alarm occurs, the display shows the icon blinking.

Press **ALARM** key to read the alarm status:

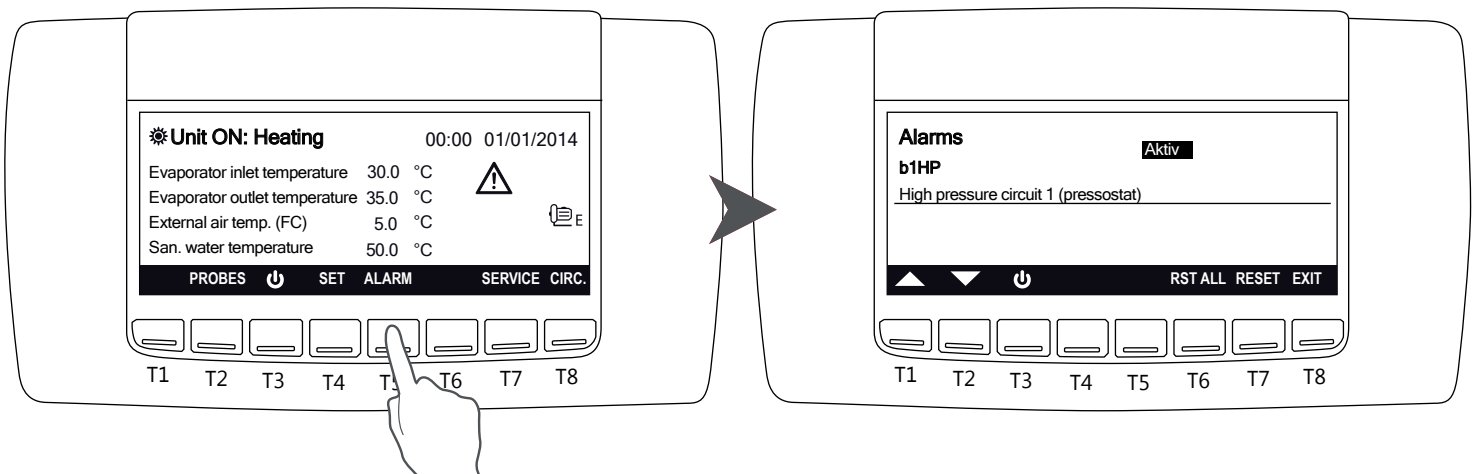

The alarm status can be:

- **Reset:** the alarm is not active and it is possible to reset it. Press and keys to select the alarm to select it and press **RESET** key to reset the alarm.
- **Password:** in this case the alarm is no longer active, but you need a password to reset it (please contact the Company).
- **Active:** the alarm is still active and it is not possible to reset it.

In case more resettable alarms are present, it's possible to reset all of them at once pressing **RST ALL** key.
 In any case, even if all the alarms are reset, they remain present in the alarm history (par. 6.7.7).

6.6 CIRC key

Pressing **CIRC** can view the different parameters of the unit:

Pressing and you move from one screen to another while with and you scroll through the menu items. Press **ENTER** key to view the values.

State of the compressors; the display shows compressors present in each circuit and the activation status of each one.

Color black: compressor running

Color white: compressor on standby

In case of use of compressors in part-loading (typically screw compressors) an icon appears to the right of the compressor showing the level of step control.

In case of use of On/Off compressors (Scroll) no icon appear to the right of the compressor.

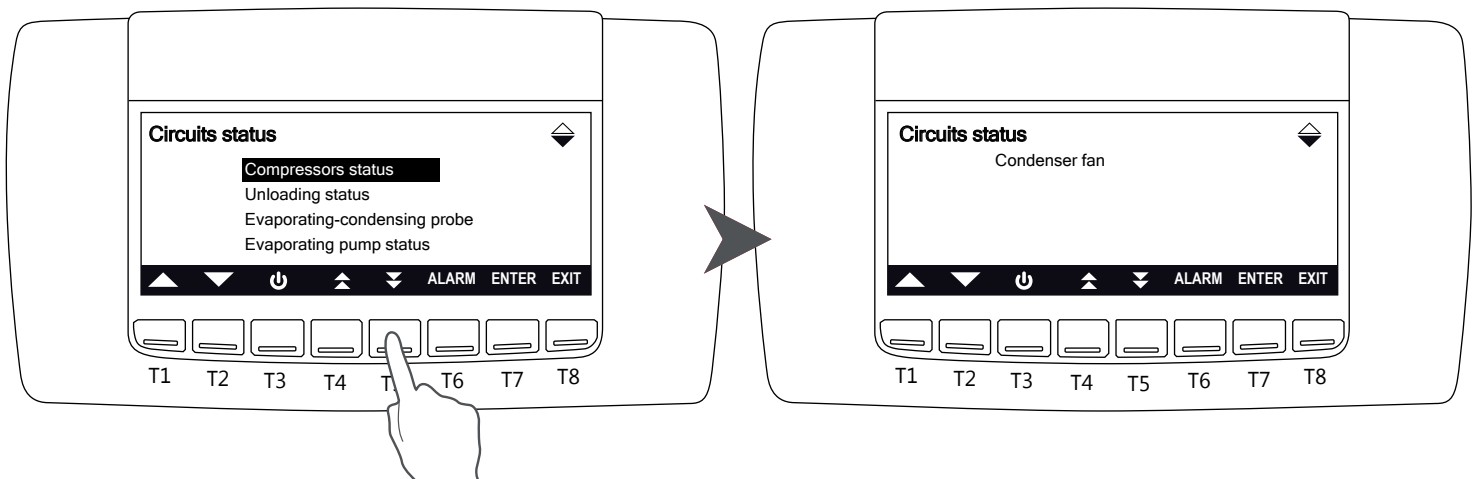
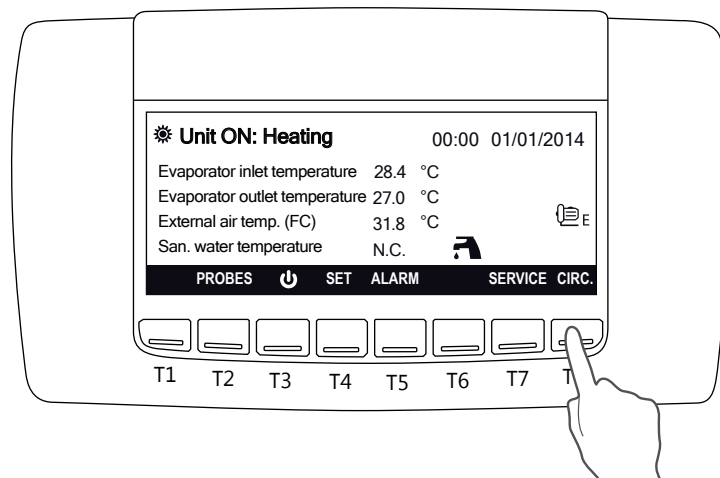

Compressor status

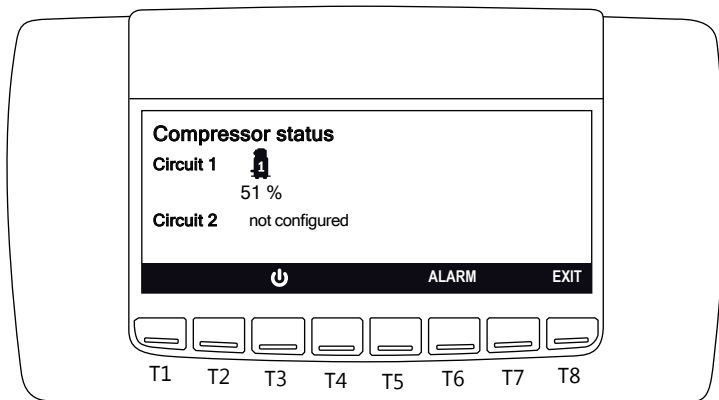

Unloading status

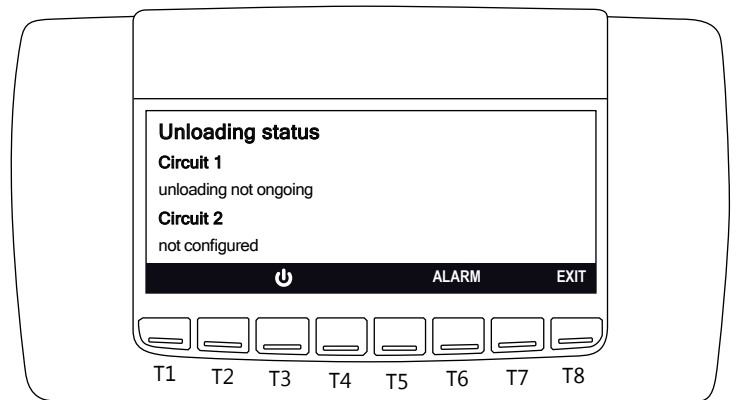

Evaporating-condensing probe

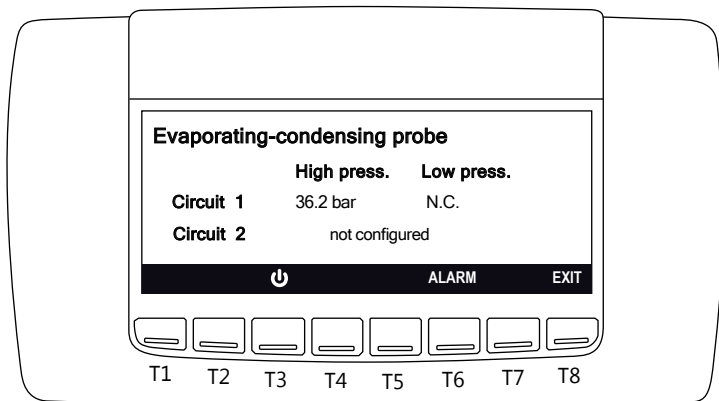

Evaporator pump status

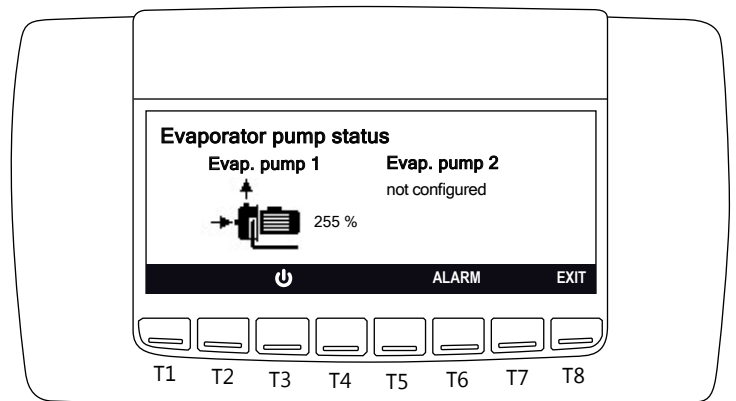



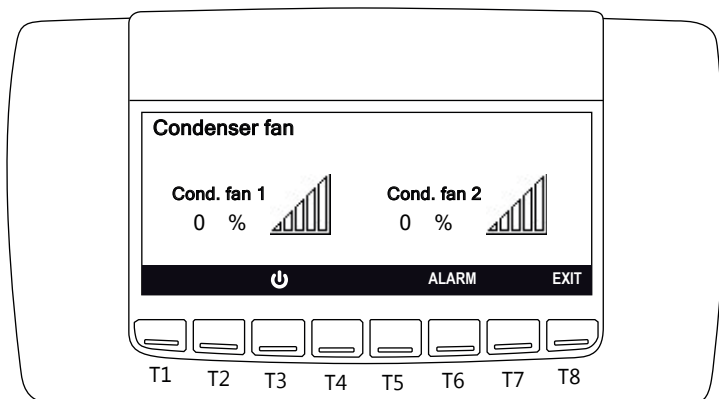



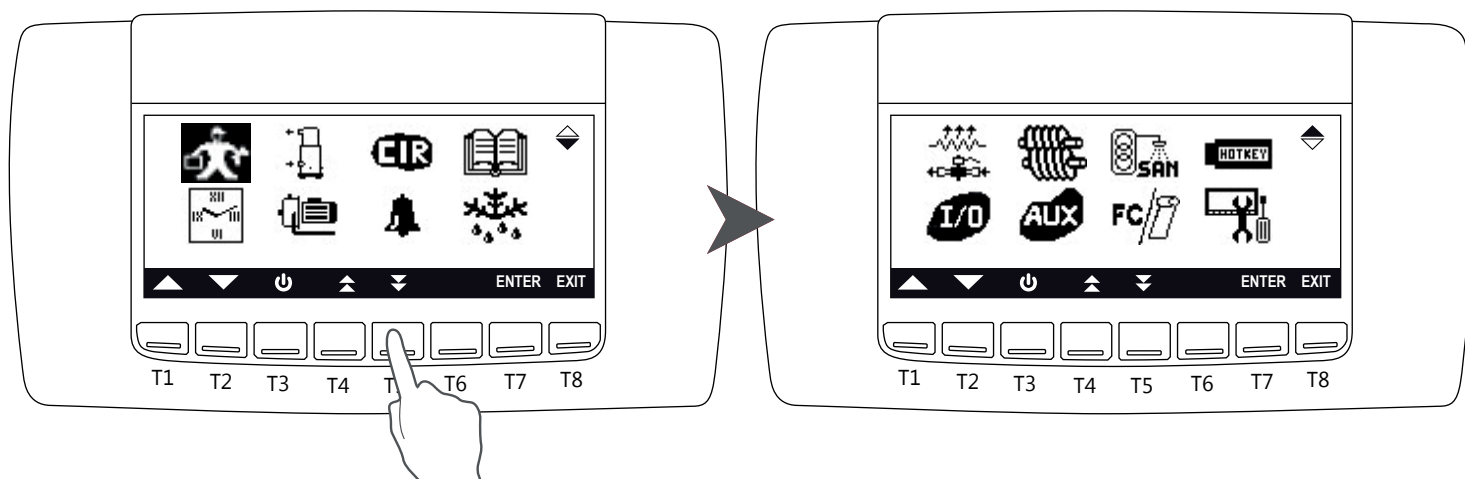









Condenser fan



6.7 SERVICE key



Press the **SERVICE** key to access the following menus:

 Setting parameters (for service only)	 Electrical heater and pump down valve status
 Time and date setting	 I/O status (Inputs and Outputs)
 Compressors status	 Screw compressor information (Not configured)
 Pumps	 Auxiliary outputs
 Circuit maintenance	 Domestic hot water (if available)
 Display of alarms	 Free cooling and Solar panel visualization (if available)
 Alarm history	 Upload and download parameter map with Hot Key
 Defrost (if available)	 Control panel

Press **▲** key to display all the menu available.

To modify and set the parameters move the cursor using the **▲** and **▼**, press **ENTER**, to select the required menu, and then **SET** to select the desired value.

Change the parameters by pressing the **▲** and **▼**, and then press **SET** again to confirm.

Press the **EXIT** key to return to the main menu.

6.7.1 Service parameters setting

To enter service menu select  moving between the icons with T1 and T2 keys and press T7.

The system prompts you to enter the password to access to different levels of security.

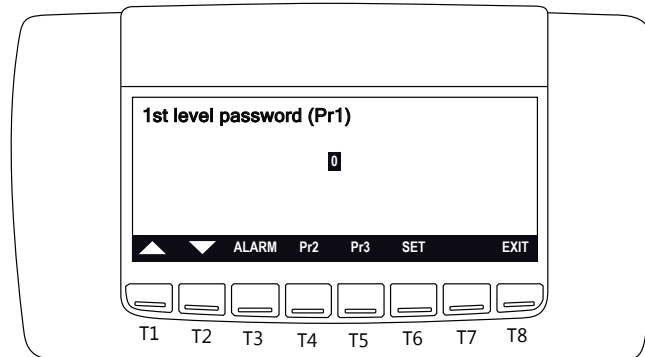

The first level allow to modify some parameters as for example heating and cooling set points and dynamic set points. Press T6 key, with T1 modify the password to 1 then press T6 again to confirm.

The display show:

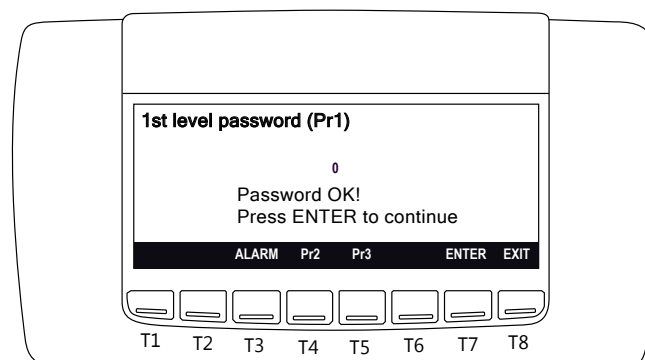

Press T1 and T2 to scroll through different groups of parameters. With password level 1 you could only change the Set Point (**St**), dynamic Set point (**Sd**), parameters of sanitary circuit (**FS**) and parameters for setting the time bands (**ES**); the unit must be switched on. Press T7 to enter in the group of parameters. Other parameters can only be modified by service with a dedicated password. Other parameters could be modified by service people only with a dedicated password.

Parameters list:

Code	Meaning	Code	Meaning
St	Set point	US	Auxiliary output
dP	Main visualization	FA	Fan
CF	Configuration	Ar	Antifreeze
Sd	Dynamic set	dF	Defrost
ES	Energy saving	FS	Sanitary water
Cr	Compressor racks	AL	Alarms
CO	Compressor		

To modify the value of the parameter: press or to select the parameter to modify then press **SET** the value start to blinking, press and to modify, than press **SET** again to confirm.

The values available in the group of parameters “Set point” (**St**) are: summer set point (St01), winter set point (St04), summer regulation band (St07) and winter regulation band (St08).

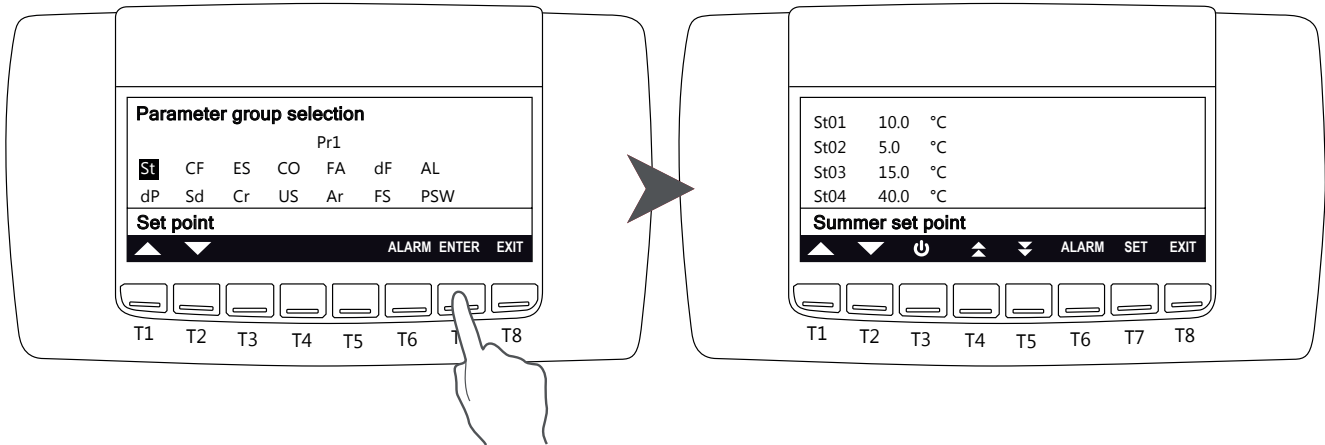

The values available in the group of parameters “Dynamic set point” (**Sd**) are: dynamic set point: summer offset (Sd01), dynamic set point: winter offset (Sd02), dynamic set point: summer outside temp. (Sd03), dynamic set point: winter outside temp. (Sd04), dynamic set point: summer differential temp. (Sd05) and dynamic set point: winter differential temp.(Sd06).

For more informations about the parameters see par. 6.3.1 and 6.3.2.

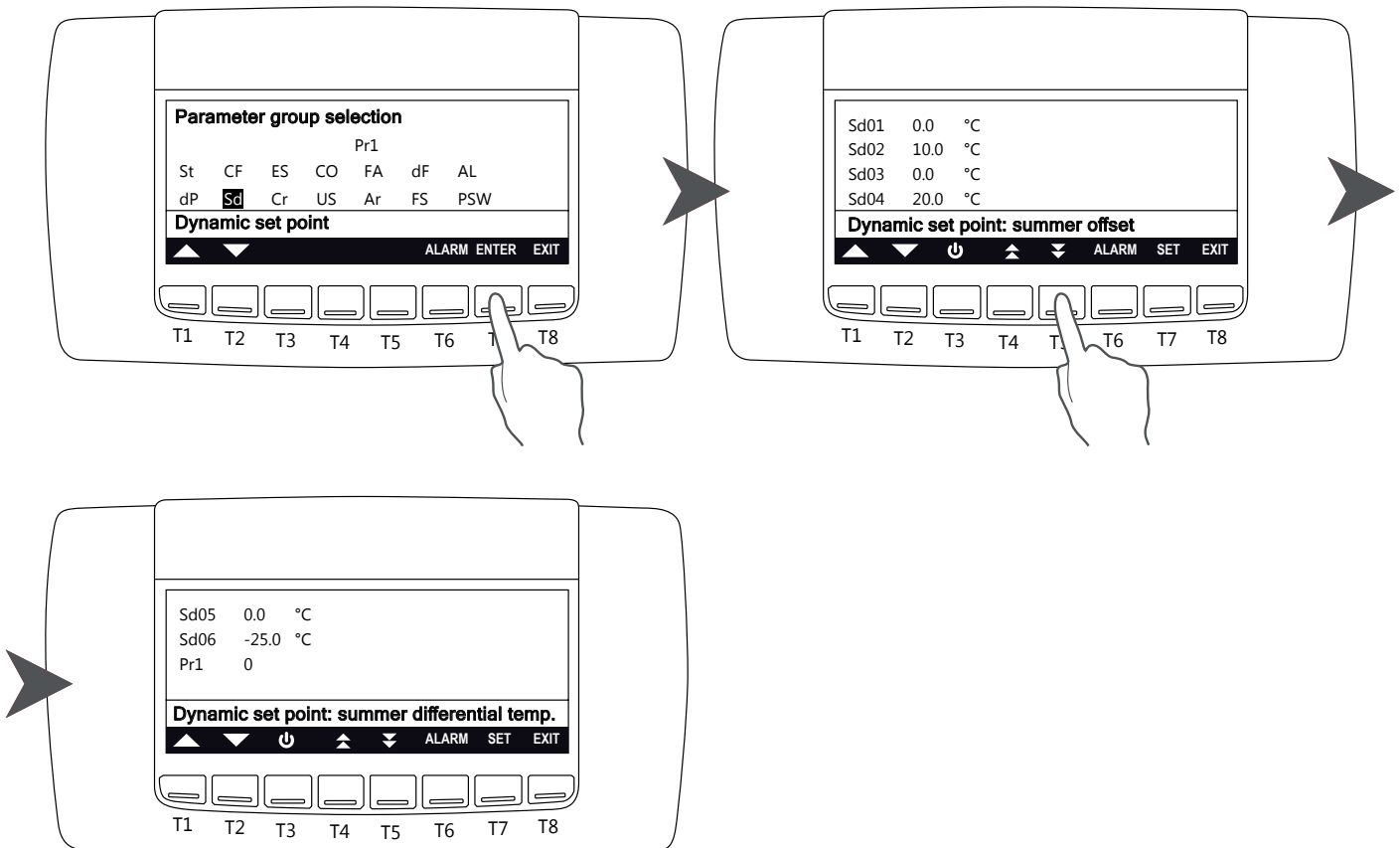

Weather compensated function

This function makes it possible to activate the weather compensation sensor in order to optimize the efficiency of the unit. Automatically it modifies the set-point value with respect to external air temperature: a calculation is performed on the set-point to provide a revised value of set point for higher ambient conditions (see example given below). This function makes it possible to save energy and to operate the unit in severe ambient conditions. This function is only active in heating mode.

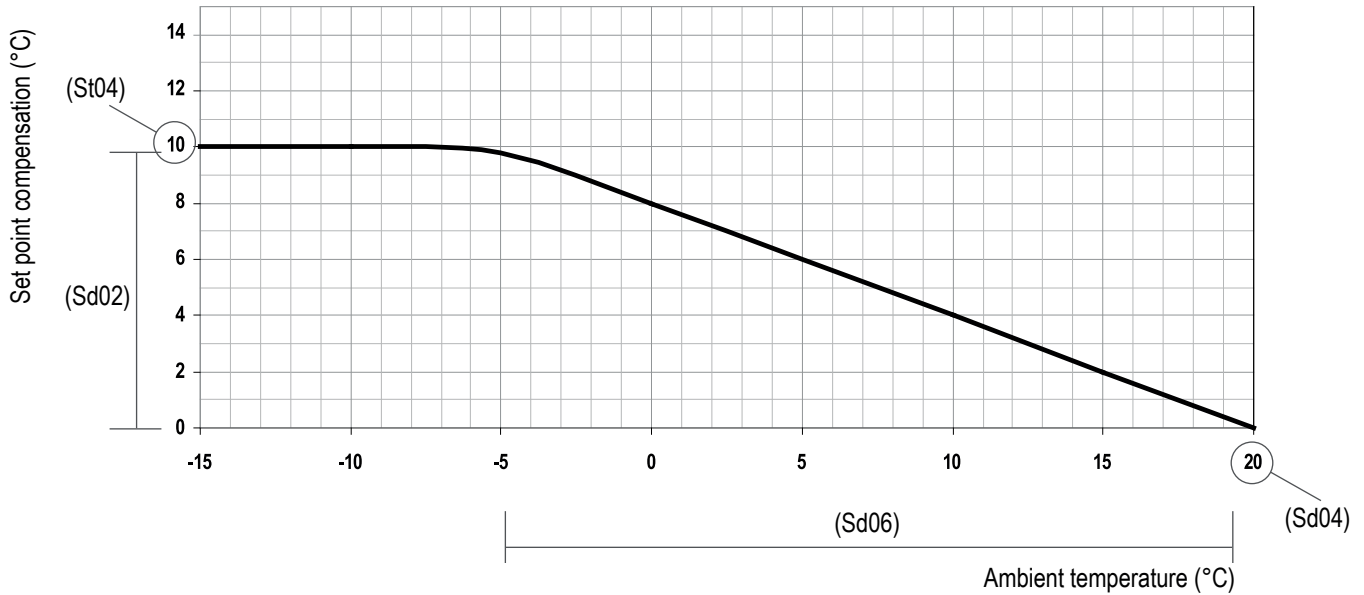

All units are factory set with the weather compensated function activated. The slope starts at +20°C with a differential of 10°C.



With the energy saving mode activated, if the SET key is pressed twice the bottom of the display shows the SETTR (weather compensated set point) label that is the specific set point calculated by the microprocessor control for the measured ambient temperature condition.

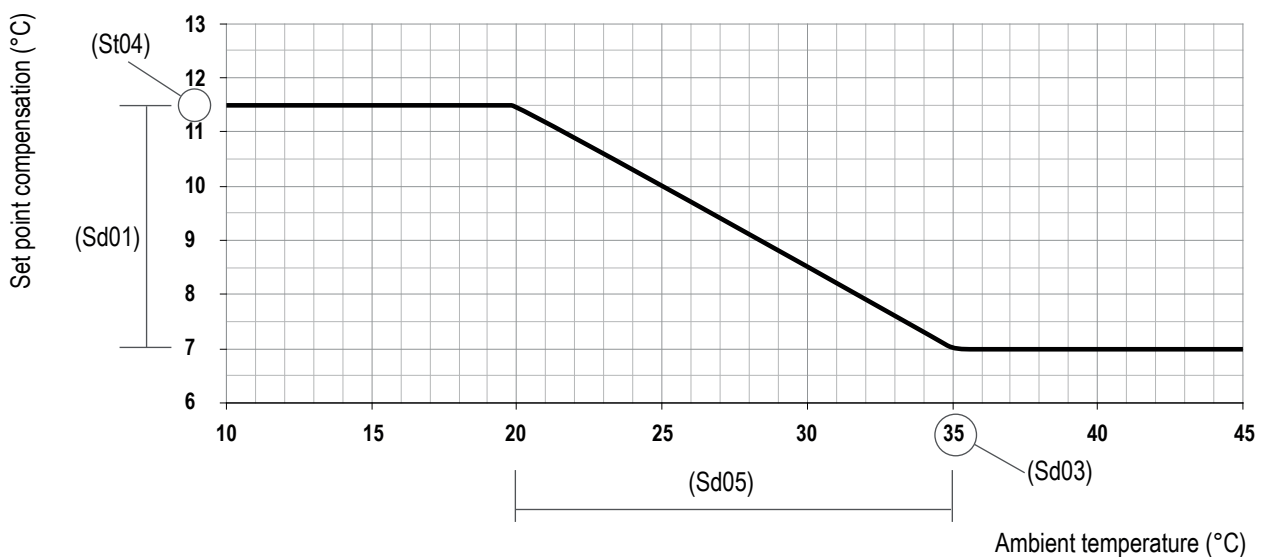

The values available in the group of parameters “Sanitary circuit” (FS) are: Sanitary water priority (FS02), Sanitary water set point (FS03), Sanitary water proportional band (FS04) .

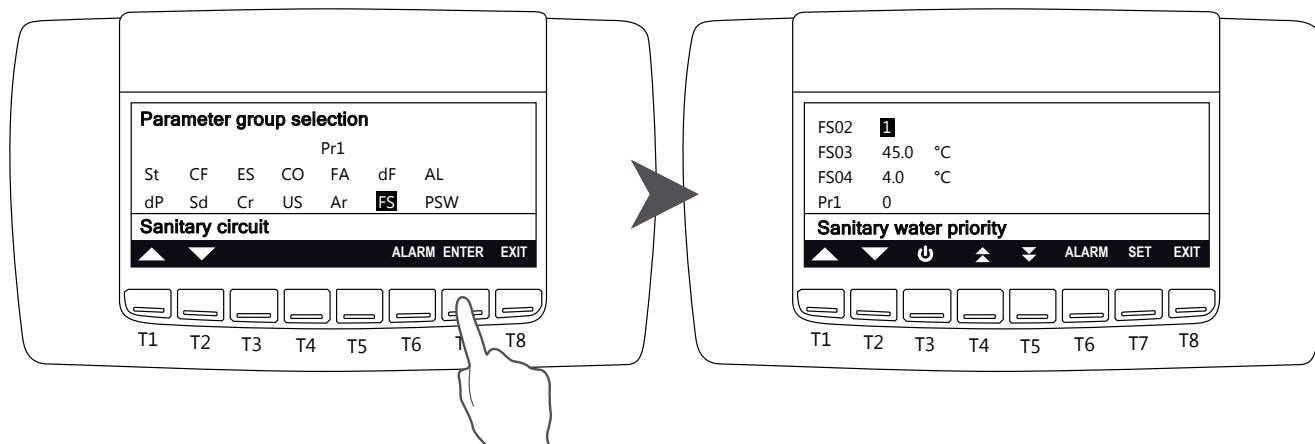

6.7.2 Time bands setting

To access the group of parameters for setting the time bands, select **ES**

ES01	Start of operating range N°1 (0÷24)	ES17	Differential energy saving set in heat pump operation
ES02	End of operating range N°1 (0÷24)	ES18	Maximum unit operating time in OFF by RTC if forced into ON by button
ES03	Start of operating range N°2 (0÷24)	ES19	Time band 1 DHW: start
ES04	End of operating range N°2 (0÷24)	ES20	Time band 1 DHW: end
ES05	Start of operating range N°3 (0÷24)	ES21	Time band 2 DHW: start
ES06	End of operating range N°3 (0÷24)	ES22	Time band 2 DHW: end
ES07	Monday with energy saving time band Monday operation with automatic on/off	ES23	Time band 3 DHW: start
ES08	Tuesday with energy saving time band Tuesday operation with automatic on/off	ES24	Time band 3 DHW: end
ES09	Wednesday with energy saving time band Wednesday operation with automatic on/off	ES25	Monday: time band selection
ES10	Thursday with energy saving time band Thursday operation with automatic on/off	ES26	Tuesday: time band selection
ES11	Friday with energy saving time band Friday operation with automatic on/off	ES27	Wednesday: time band selection
ES12	Saturday with energy saving time band Saturday operation with automatic on/off	ES28	Thursday: time band selection
ES13	Sunday with energy saving time band Sunday operation with automatic on/off	ES29	Friday: time band selection
ES14	Increased energy saving set in chiller operation	ES30	Saturday: time band selection
ES15	Differential energy saving set in chiller operation	ES31	Sunday: time band selection
ES16	Increased energy saving set in heat pump operation	ES32	Energy saving: offset DHW setpoint

Sets of time bands that can be set on different days of the week are:

- 0 = None
- 1 = Time band 1
- 2 = Time band 2
- 3 = Time bands 1 and 2
- 4 = Time band 3
- 5 = Time bands 1 and 3
- 6 = Time bands 2 and 3
- 7 = All time bands

Operating modes

The possible operating modes are:

- **Automatic ON-OFF:** automatic switching on and off of the unit according to set times.
- **Energy Saving:** Allows you to set two different set points, for example one for the day and one for the night.

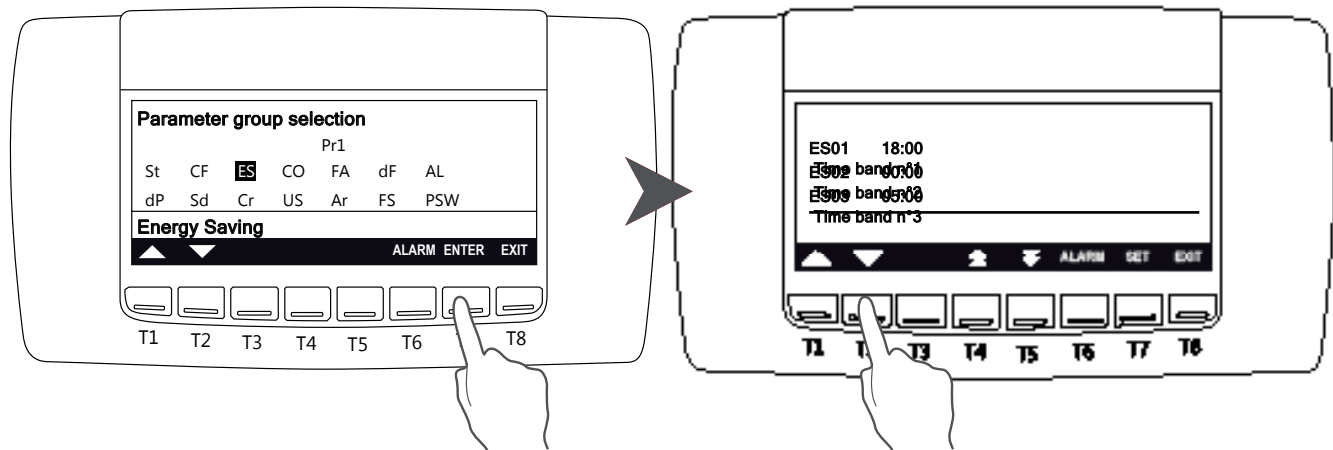

Up to three time bands can be set.

Select the time to be changed by moving with T1 and T2 keys confirm the parameter select with T7 key than change the values with T1 and T2 keys.

Press T5 key to view all available parameters.

6.7.3 Setting date and time

To enter this menu select  moving between the icons with the keys T1 and T2 and press T7.

Press T1 and T2 to select the value you want to edit than press T7. The selected parameter will start blinking, press T1 and T2 to set the value and than press T7 to confirm.

Pressing T5 it is possible to read the information about the Energy saving, ON/OFF scheduling and time bands. To modify the hour of the time band and to enable the function is necessary to insert the password, in case you do not have a password, you can only view the different parameters..

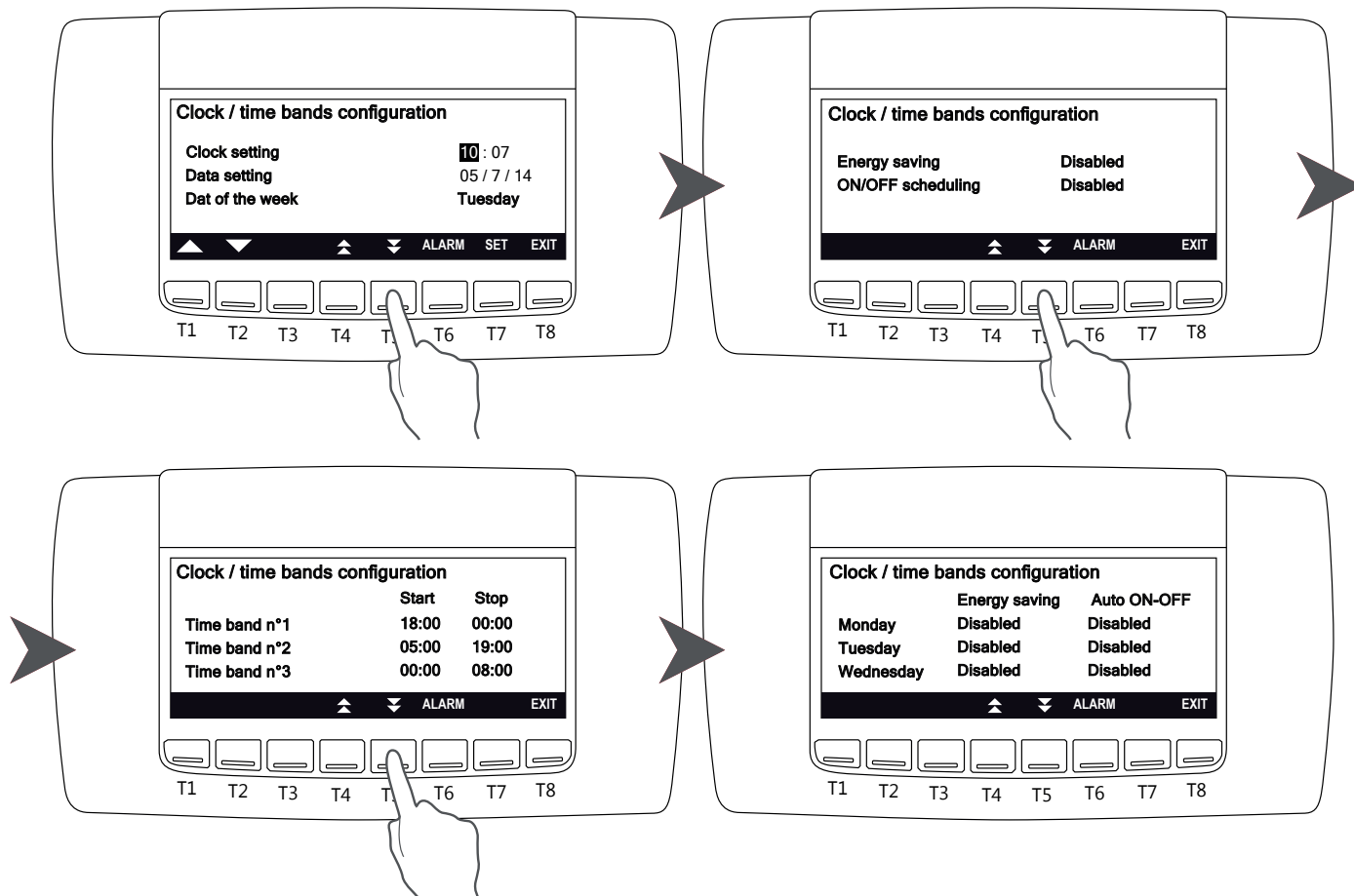

6.7.4 Compressor maintenance



To enter this menu select moving between the icons with the keys T1 and T2 and press T7.

It is possible to display the compressors working hour and the number of activations. Select the circuit with the keys T1 and T2 than press T7 to display the parameters. The disabling function of the compressors T7 is only possible by service people.

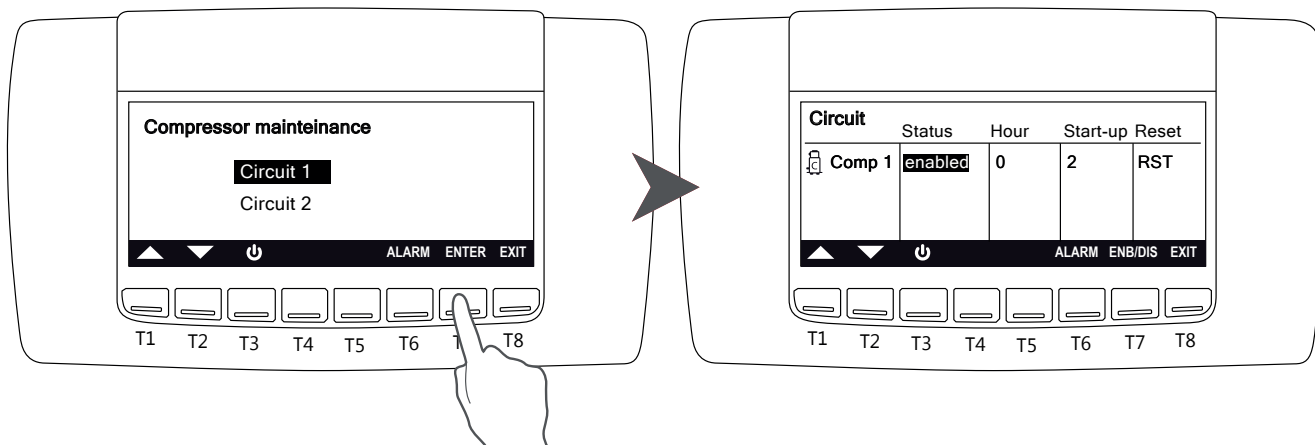

6.7.5 Water pumps



To enter this menu select moving between the icons with the keys T1 and T2 and press T7.

It is possible to display the working hours of water pumps. The function T7 is only possible by service people.

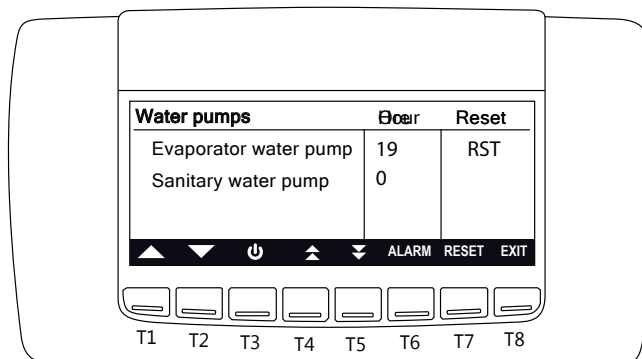

6.7.6 Circuit maintenance



To enter this menu select moving between the icons with the keys T1 and T2 and press T7.

It is possible to display the status of the circuits. The function T7 is only possible by service people.

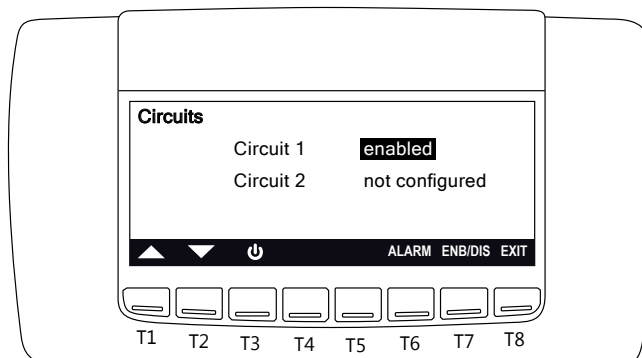

6.7.7 Alarms

To enter this menu select  moving between the icons with the keys T1 and T2 and press T7.

For the management of alarms see par. 6.5.

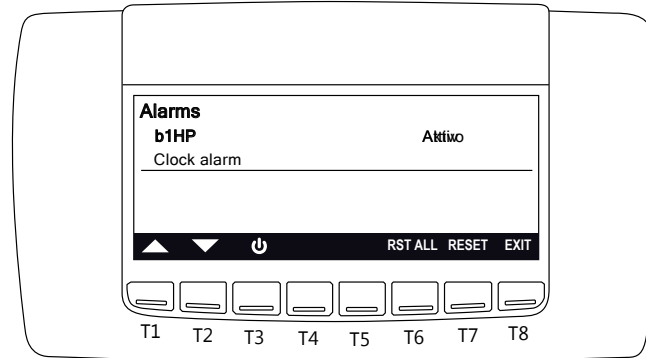

6.7.8 Alarm log

To enter this menu select  moving between the icons with the keys T1 and T2 and press T7.

Pressing T4 and T5 it is possible to read the last 99 alarms. The function of reset of all alarms T7 is only possible by service people.

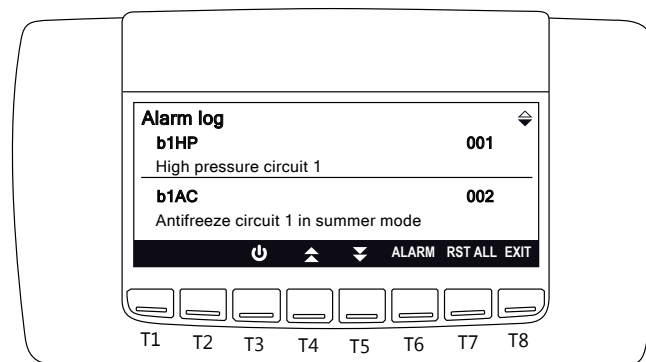

6.7.9 Defrost

To enter this menu select  moving between the icons with the keys T1 and T2 and press T7.

For each circuit it is possible to read the status of the defrost and, after selecting the circuit, pressing the T7 key it is possible to display some parameters relating to the defrosting of the circuit (values related to the probes and to the set points).

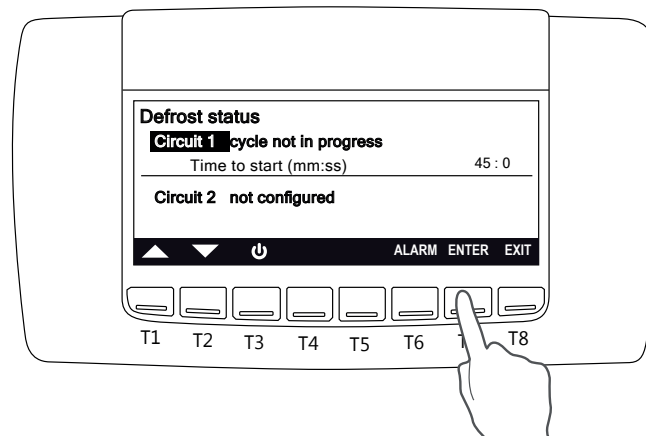

Press T4 and T5 to display all the available parameters.

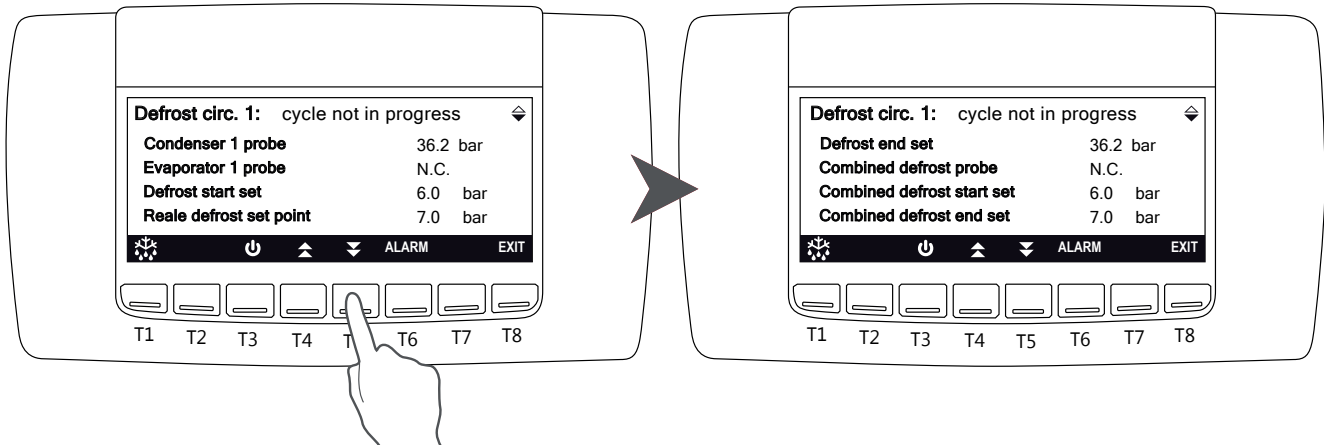

6.7.10 Eletrical heater



To enter this menu select  moving between the icons with the keys T1 and T2 and press T7. It is possible to read the status of the electrical heaters.

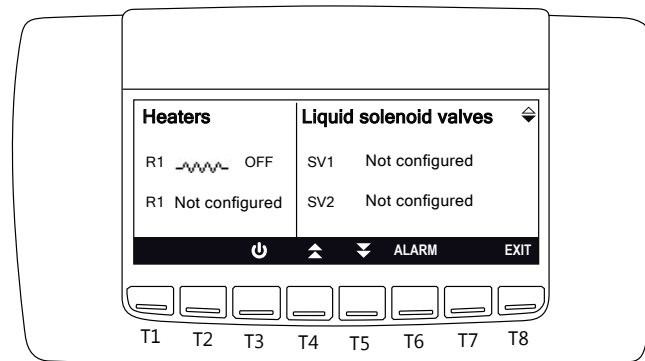

6.7.11 I/O Status (Input/Output)



To enter this menu select  moving between the icons with the keys T1 and T2 and press T7. It is possible to display: probes status, analog input and output, digital input and output.

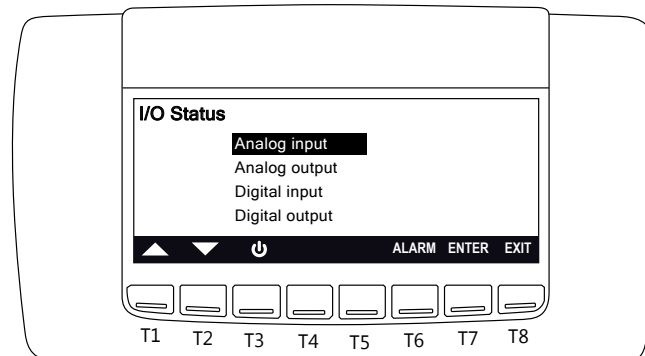

6.7.12 Screw compressor (If available)



To enter this menu select moving between the icons with the keys T1 and T2 and press T7.

In the main screen it is possible to display the discharge temperature and the liquid injection set point. Press T4 and T5 keys to select the required circuit than press T7 key to read the discharge temperature and the status of the valves.

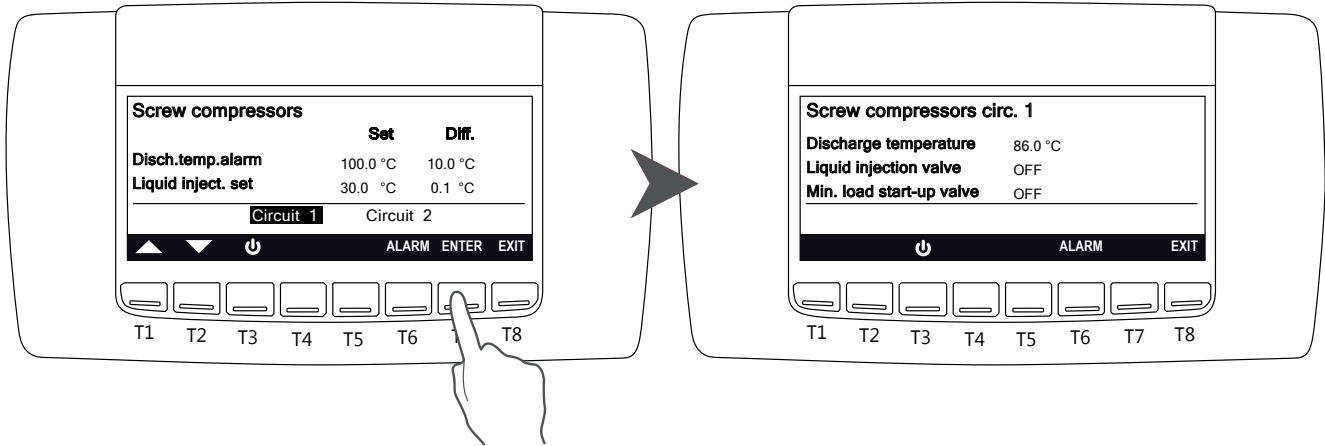

6.7.13 Auxiliary output



To enter this menu select moving between the icons with the keys T1 and T2 and press T7.

It is possible to read informations about auxiliary outputs.

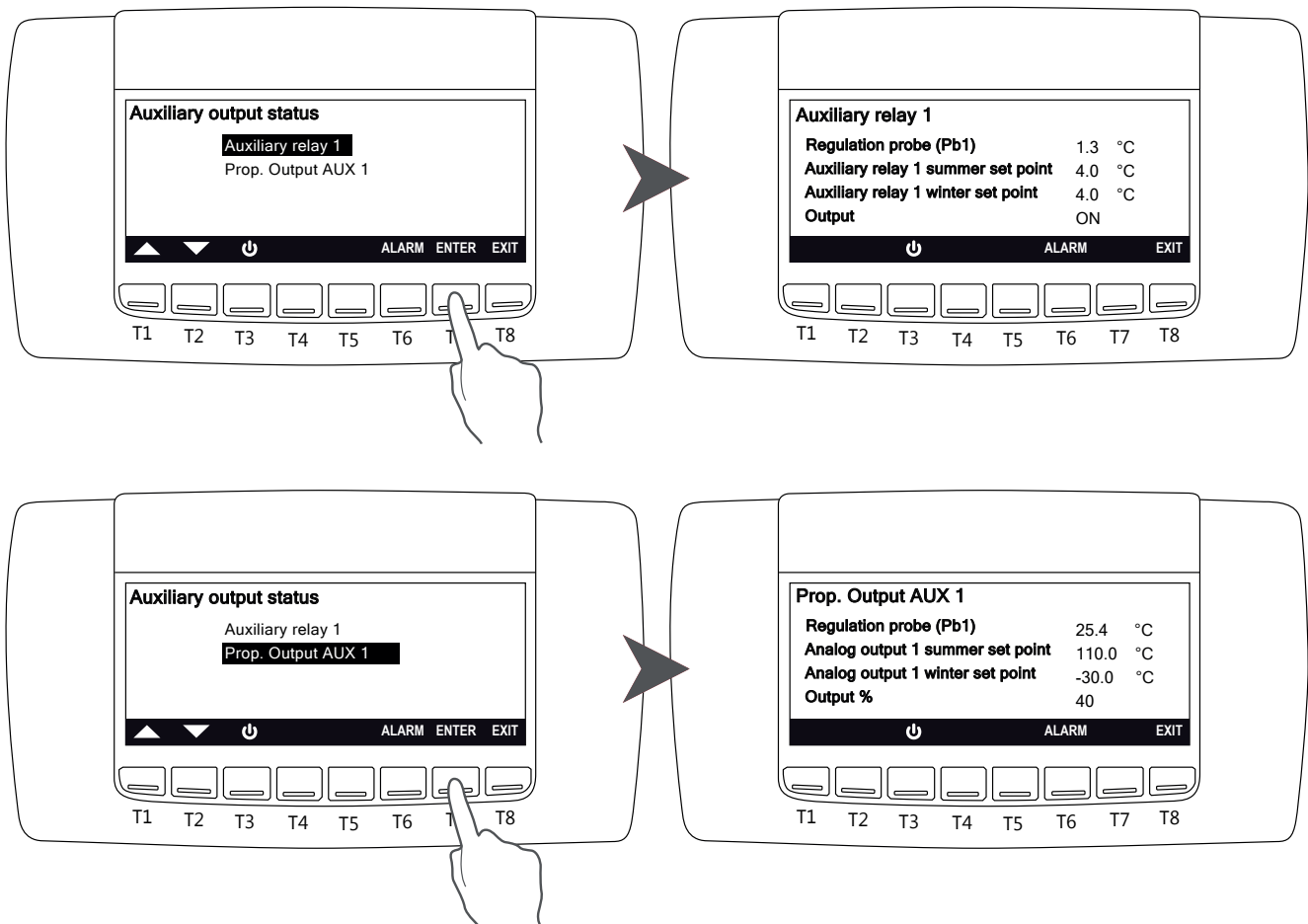

6.7.14 Sanitary water



To enter this menu select **SAN** moving between the icons with the keys T1 and T2 and press T7.

It is possible to read informations of the sanitary water regulation. Press T7 key to modify the values.

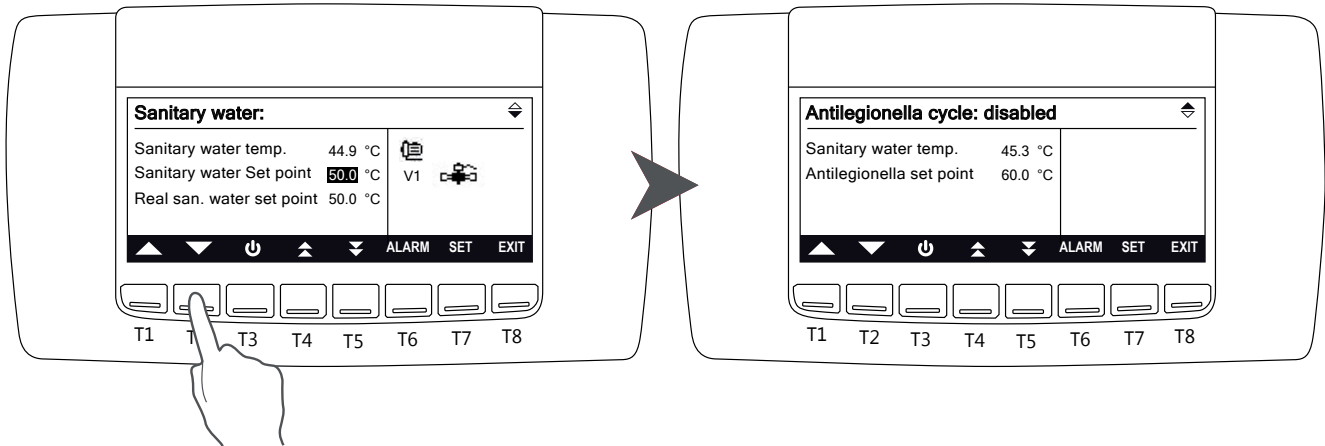

6.7.15 Upload / download



To enter this menu select **HOTKEY** moving between the icons with the keys T1 and T2 and press T7.

This function is allowed only to the service.

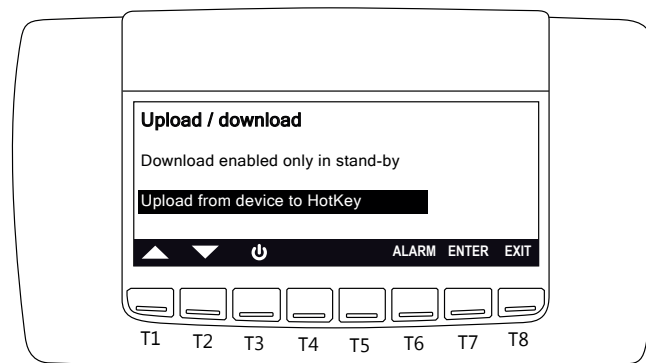

6.7.16 Control panel



To enter this menu select **SAN** moving between the icons with the keys T1 and T2 and press T7.

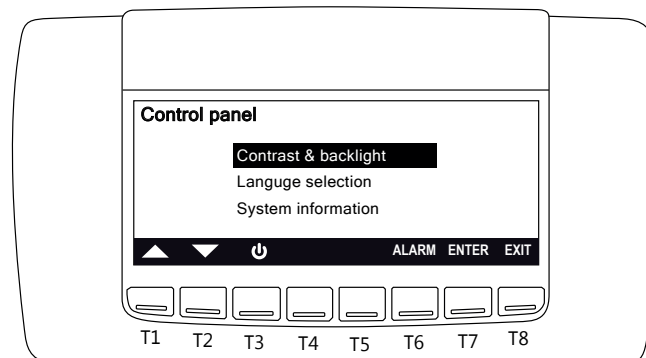

6.8 Acoustic signal silencing

Pressing and releasing one of the keys; the buzzer is switched off, even if the alarm condition remains in place.

7. MAINTENANCE OF THE UNIT

7.1 General warnings



Starting from 01/01/2016 the new European Regulation 517_2014, "Obligations concerning the containment, use, recovery and destruction of fluorinated greenhouse gases used in stationary refrigeration, air conditioning and heat pumps", became effective. This unit is subject to the following regulatory obligations, which have to be fulfilled by all operators:

- (a) Keeping the equipment records
- (b) Correct installation, maintenance and repair of equipment
- (c) Leakage control
- (d) Refrigerant recovery and disposal management
- (e) Presentation to the Ministry of the Environment of the annual declaration concerning the atmospheric emissions of fluorinated greenhouse gases.

Maintenance can:

- Keep the equipment operating efficiently
- Prevent failures
- Increase the equipment life



It is advisable to maintain a record book for the unit which details all operations performed on the unit as this will facilitate troubleshooting.



Maintenance must be performed in compliance with all requirements of the previous paragraphs.



Use personal protective equipment required by regulations as compressor casings and discharge pipes are at high temperatures. Coil fins are sharp and present a cutting hazard.



If the unit is not to be used during the winter period, the water contained in the pipes may freeze and cause serious damage. In this event, fully drain the water from the pipes, checking that all parts of the circuit are empty including any internal or external traps and siphons.



If it is necessary to replace a component of the machine, both for ordinary and extraordinary maintenance, this component must have the same or higher characteristics than those present. The same or higher performances or thicknesses are meant for the characteristics, which do not compromise the safety, the use, the handling, the storage, the pressures and the temperatures of use of the machine provided by the manufacturer.



The taps in the machine must always be in open position before starting. If it is necessary to disconnect the refrigeration circuit by closing the taps, it is necessary to take precautions to prevent the unit from starting up, even accidentally, and to indicate that the taps have been properly closed with special signs, both on the tap and in the electrical panel. In any case, the taps must remain closed as less as possible.

7.2 Drive access

Access to the unit once installed, should only be possible to authorized operators and technicians. The owner of the equipment is the company legal representative, entity or person owns the property where the machine is installed.

They are fully responsible for all safety rules given in this manual and regulations. If it is not possible to prevent access to the machine by outsiders, a fenced area around the machine at least 1.5 meters away from external surfaces in which operators and technicians only can operate, must be provided.

7.3 Scheduled maintenance

The owner must make sure that the unit is periodically inspected, also on-site, adequately maintained, according to the type, size, age and use of the system, and to the indications contained in the Manual.

Servicing during the unit's operating lifetime and, in particular, scheduled leak detection, on-site inspections and check-ups of safety equipment, must be carried out as provided by local laws and regulations in force.



If leak detection instruments are installed on the system, they must be inspected at least once a year, to make sure that they work properly.

During its operating life, the unit shall be inspected and verified in accordance with applicable local laws and regulations. In particular, when there are no stricter specifications, the indications given in the following table (see EN 378-4, Annex D) must be followed, with reference to the situations described.

CASE	Visual Inspection	Pressure Test	Search for leaks
A	X	X	X
B	X	X	X
C	X		X
D	X		X

A	Inspection after an intervention with possible effects on the mechanical strength or after use change or in case the machine has not being working for more than two years. Replace all the components which are not suitable any more. Do not carry out checks at a higher pressure than the one indicated in the project.
B	Inspection after a repair, or significant adjustment of the system, or its components. The check may be limited to the interested parts, but if a leakage of refrigerant is detected, a leakage search must be carried out on the entire system.
C	Inspection after installation in a different position than the original one. Refer to point A when mechanical strength could have been affected by the change.
D	Leak search, following a well-founded suspicion of refrigerant leakage. It is recommended examined the system for leakage, either directly (use of leak detection systems) or indirectly (deduction of leakage based on analysis of operating parameters), focusing on the parts most prone to leakage (e.g. joints).



If a defect is detected that compromises the reliable operation of the unit, the unit cannot be re-started until it has been repaired.

7.4 Periodical checks and start up



The start-up operations should be performed in compliance with all requirements of the previous paragraphs.



All of the operations described in this chapter **MUST BE PERFORMED BY TRAINED PERSONNEL ONLY**. Before commencing service work on the unit ensure that the electric supply is disconnected. The top case and discharge line of compressor are usually at high temperature. Care must be taken when working in their surroundings. Aluminium coil fins are very sharp and can cause serious wounds. Care must be taken when working in their surroundings. After servicing, replace the cover panels, fixing them with locking screws.

7.4.1 Electrical system and adjustment

Action to be performed	Frequency					
	Monthly	Every 2 months	Every 6 months	Every year	Every 5 years	As necessary
Check that the unit works properly and that there are no active warnings	X					
Visually inspect the unit	X					
Check noise and vibration level of the unit				X		
Check operation of safety features and of interlocks				X		
Check the unit's performance				X		
Check the current draws of the different parts (compressors, fans, pumps, etc.)				X		
Check the supply voltage of the unit			X			
Check tightness of cables in their clamps			X			
Check the integrity of the insulating coating of power cables				X		
Check the conditions and functioning of the counters				X		
Check functioning of the microprocessor and of the display			X			
Clean the electrical and electronic components of any dust				X		
Check functioning and calibration of probes and transducers				X		

7.4.2 Condensing coils and fans

Action to be performed	Frequency					
	Monthly	Every 2 months	Every 6 months	Every year	Every 5 years	As necessary
Visually inspect the coil	X					
Clean finned coils ⁽¹⁾			X			
Check the water flow and/or any leaks	X					
Check that the flow switch is working properly			X			
Clean the metal filter on the water line ⁽³⁾			X			
Check noise and vibration level of the fans				X		
Check the supply voltage of the fans			X			
Check the fans' electrical connections				X		
Check functioning and calibration of the fans' speed adjustment system (if present)				X		
Check 4-way valve operation (if present)				X		
Check air presence in the hydraulic circuit	X					
Check color of moisture indicator on liquid line				X		
Check for freon leaks ⁽²⁾						X



⁽¹⁾ If the unit is installed in strongly windy areas, near coasts or deserts or in areas subjects to wind and/or sand storms, or near airports, industries or in places with high levels of air pollution in general inspect the unit more frequently (**every three months or more**) to check the real condition of the surface protection.



⁽²⁾ In order to carry out operations on the refrigerant, it is necessary to observe the European Regulation 517_2014, "Obligations regarding the containment, use, recovery and destruction of fluorinated greenhouse gases used in stationary refrigeration, air conditioning and heat pump equipment".



⁽³⁾ It can be carried out with a higher frequency (also weekly) depending on the Δt .

7.4.3 Compressors

Action to be performed	Frequency					
	Monthly	Every 2 months	Every 6 months	Every year	Every 5 years	As necessary
Visually inspect compressors				X		
Check noise and vibration level of the compressors				X		
Check the supply voltage of the compressors			X			
Check the compressors' electrical connections				X		
Check oil level in the compressors using the oil fill level indicator			X			
Check that the crankcase heaters are powered and working properly				X		
Check the conditions of the compressors' power cables and their tightness in the clamps			X			



Daily and monthly works may be carried out directly by the Owner of the system. All other works must be performed by authorised and trained personnel.



Any kind of cleaning whatsoever is forbidden before disconnecting the device from power supply by turning the master switch to the OFF position. It is forbidden to touch the device while barefooted or with wet or damp body parts.



Works on the cooling line must be carried out by qualified and trained technicians, as provided by local laws and regulations in force.



Before the start-up it is necessary to carry out all the operations described in the previous tables and make the necessary checks provided by the pre-start control module (valid for the Italian market) to be requested to the service.

7.5 Refrigerant circuit repair



If the refrigerant circuit is to be emptied, all the refrigerant must be recovered using the correct equipment.

For leak detection, the system should be charged with nitrogen using a gas bottle with a pressure reducing valve, until 15 bar pressure is reached. Any leakage is detected using a bubble leak finder. If bubbles appear discharge the nitrogen from the circuit before brazing using the proper alloys.



Never use oxygen instead of nitrogen: explosions may occur.

Site assembled refrigerant circuits must be assembled and maintained carefully, in order to prevent malfunctions.

Therefore:

- Avoid oil replenishment with products that are different from that specified and that are pre-loaded into the compressor.
- In the event of a gas leakage on machines using refrigerant R407C, even if it is only a partial leak, do not top up. The entire charge must be recovered, the leak repaired and a new refrigerant charge weighed in to the circuit.
- When replacing any part of the refrigerant circuit, do not leave it exposed for more than 15 minutes.
- It is important when replacing a compressor that the task be completed within the time specified above after removing the rubber sealing caps.
- When replacing the compressor following a burn out, it is advisable to wash the cooling system with appropriate products including a filter for acid.
- When under vacuum do not switch on the compressor.

8. DECOMMISSIONING

8.1 Disconnect the unit



All decommissioning operations must be performed by authorized personnel in accordance with the national legislation in force in the country where the unit is located.

- Avoid spills or leaks into the environment.
- Before disconnecting the machine please recover:
 - the refrigerant gas;
 - Glycol mixture in the hydraulic circuit;
 - the compressor lubricating oil.

Before decommissioning the machine can be stored outdoors, providing that it has the electrical box, refrigerant circuit and hydraulic circuit intact and closed.

8.2 Disposal, recovery and recycling

The frame and components, if unusable, should be taken apart and sorted by type, especially copper and aluminum that are present in large quantities in the machine.

All materials must be recovered or disposed in accordance with national regulations.



The refrigerant circuit of the unit contains lubricant oil that binds the disposal mode of components .

8.3 RAEE Directive (only UE)



The crossed-out bin symbol on the label indicates that the product complies with regulations on waste electrical and electronic equipment. The abandonment of the equipment in the environment or its illegal disposal is punishable by law.

This product is included in the application of Directive 2012/19/EU on the management of waste electrical and electronic equipment (WEEE).

The unit should not be treated with household waste as it is made of different materials that can be recycled at the appropriate facilities. Inform through the municipal authority about the location of the ecological platforms that can receive the product for disposal and its subsequent proper recycling.

The product is not potentially dangerous for human health and the environment, as it does not contain dangerous substances as per Directive 2011/65/EU (RoHS), but if abandoned in the environment it has a negative impact on the ecosystem.

Read the instructions carefully before using the unit for the first time. It is recommended not to use the product for any purpose other than that for which it was designed, as there is a risk of electric shock if used improperly.

9. DIAGNOSIS AND TROUBLESHOOTING

9.1 Fault finding

All units are checked and tested at the factory before shipment, however, during operation an anomaly or failure can occur.



BE SURE TO RESET AN ALARM ONLY AFTER YOU HAVE REMOVED THE CAUSE OF THE FAULT; REPEATED RESET MAY RESULT IN IRREVOCABLE DAMAGE TO THE UNIT.

Code	Alarm Description	Cause	Solution
ACF1	Configuration alarm	Wrong configuration of microprocessor control system.	Contact the company.
ACF2	Configuration alarm		
ACF3	Configuration alarm		
ACF4	Configuration alarm		
ACF5	Configuration alarm		
ACF6	Configuration alarm		
ACF7	Configuration alarm		
ACF8	Configuration alarm		
ACF9	Configuration alarm		
AEE	Eeprom alarm	Severe hardware damage in the microprocessor control system.	Switch OFF the unit and, after few second switch ON the unit; if the alarm appears again contact the service.
AEFL	User water flow switch alarm	Presence of air or dirtiness in the user hydraulic system.	Bleed carefully the user hydraulic system or check and clean the water strainer.
AEU _n	Compressor unloading alarm (only units with 2 compressors)	User water temperature is too high.	Wait until the user water temperature is lower.
AHFL	Domestic hot water flow switch alarm	Presence of air or dirtiness in the user hydraulic system.	Bleed carefully the user hydraulic system or check and clean the water strainer.

Code	Alarm Description	Cause	Solution
AP1	Alarm user inlet water temperature sensor	Wrong electrical connection, Sensor defect.	Check the electrical connection of the sensor to the terminal board, if correct call the service to replace the sensor.
AP10	Alarm safety domestic hot water sensor		
AP2	Alarm user outlet water temperature sensor		
AP3	Alarm pressure transducer		
AP4	Alarm finned coil sensor / defrost sensor		
AP5	Alarm domestic hot water inlet temperature sensor		
AP6	Alarm domestic hot water outlet temperature sensor		
AP7	Alarm ambient sensor	Wrong electrical connection, Sensor defect.	Check the electrical connection of the sensor to the terminal board, if correct call the service to replace the sensor.
AP8	Not used		
AP9	Not used		
AtE1	Evaporator water pump 1 overload		
AtE2	Evaporator water pump 2 overload		
B1 HP	High pressure switch circuit 1	<p>In heating mode: Insufficient user circuit water flow; Insufficient domestic hot water circuit water flow.</p> <p>In cooling mode: Insufficient air flow at the source fan; Insufficient domestic hot water circuit water flow.</p>	<p>Restore the correct user circuit water flow. Restore the correct domestic hot water circuit water flow.</p> <p>Restore the correct air flow to source fan. Restore the correct domestic hot water circuit water flow.</p>
b1AC	Anti-freeze alarm circuit 1 (cooling mode)	Too low water temperature	Check user temperature set point; Check user water flow.
b1AH	Anti-freeze alarm circuit 1 (heating mode)	Too low water temperature	Check user temperature set point.
b1dF	Wrong defrost circuit 1 (maximum time admitted)	Defrost time too long; Outside temperature outside the working limits; Refrigerant charge leakage.	Check defrost set point; Restore normal working conditions; Find leakage and repair.
b1hP	High pressure transducer alarm circuit 1	Transducer defect	Replace the faulty transducer.
B1LP	Low pressure switch circuit 1	Refrigerant charge leakage.	Find leakage and repair.
b1IP	Low pressure transducer alarm circuit 1	Transducer defect	Replace the faulty transducer.

b1tF	Overload source fan alarm	Fan input current outside operation limits.	Check the proper operation of the source fan and, in case replace it.
C1tr	Compressor 1 overload	Compressor 1 input current outside operation limits.	Replace the compressor.
C2tr	Compressor 2 overload	Compressor 1 input current outside operation limits.	Replace the compressor.



Technical data shown in this booklet are not binding.

The Company shall have the right to introduce at any time whatever modifications necessary to the improvement of the product.
The reference languages for the whole documentation are Italian and English. The other languages are to be considered only as guidelines.
